

About this Manual

We've added this manual to the Agilent website in an effort to help you support your product. This manual is the best copy we could find; it may be incomplete or contain dated information. If we find a more recent copy in the future, we will add it to the Agilent website.

Support for Your Product

Agilent no longer sells or supports this product. Our service centers may be able to perform calibration if no repair parts are needed, but no other support from Agilent is available. You will find any other available product information on the Agilent Test & Measurement website, www.tm.agilent.com.

HP References in this Manual

This manual may contain references to HP or Hewlett-Packard. Please note that Hewlett-Packard's former test and measurement, semiconductor products and chemical analysis businesses are now part of Agilent Technologies. We have made no changes to this manual copy. In other documentation, to reduce potential confusion, the only change to product numbers and names has been in the company name prefix: where a product number/name was HP XXXX the current name/number is now Agilent XXXX. For example, model number HP8648A is now model number Agilent 8648A.

Latest HP ProBER 2 Information

For the latest HP ProBER 2 information including Frequently Asked Questions, please refer to the following URL on the WorldWide Web:

<http://www.hp.com/go/prober>

HP ProBER 2

Introduction

Manual Conventions

The conventions used in this manual to illustrate instrument keys and display information are as follows:

MENU

This is an example of a hardkey. They are located below the display in the handle of HP ProBER 2 and give access to different sets of instrument settings. The key shown here accesses the main menu of the instrument and returns the cursor to the top of the display.

Tx + Rx

This is an example of a softkey. They are located immediately below the display and are used to select instrument settings. The functions associated with softkeys are shown in the display directly above the softkey and change as you move the display cursor from one instrument setting to another.

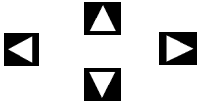

These are the cursor control keys. They are located in the handle and are used to move the display cursor from one instrument setting to another.

Introduction

HP ProBER 2 - an overview

2 Mb/s BER and signal quality measurements in a hand-held tester

The HP ProBER 2 test set provides a powerful hand-held solution for testing 2 Mb/s and 64 kb/s digital circuits. It offers extensive BER test functions plus a unique range of signal quality measurements (pulse mask, jitter, level and frequency). This unmatched (in a hand-held) test capability, combined with the intuitive operation of HP ProBER 2, simplifies installation and maintenance testing for faster problem resolution.

A range of signal quality measurements for faster problem resolution

Save time by quickly identifying signal quality problems before running long-term error measurements or during trouble-shooting. With a single keystroke, HP ProBER 2 rapidly identifies any frequency, level, pulse shape or jitter problem on a 2 Mb/s signal.

Measurement summary

HP ProBER 2 supports comprehensive functional and parametric capability providing the ability to fully evaluate 2 Mb/s, n x 64 kb/s and 64 kb/s co-directional circuits.

- Extensive error and alarm generation and measurement
 - ITU-T recommendations G.821, G.826 and M.2100 performance analysis
 - Frequency and level measurements
 - Pulse mask measurements (+ pulse, – pulse, pulse width ratio, pulse amplitude ratio)
 - Jitter measurements to ITU-T standard O.172 (supports pointer jitter tests)
 - Delay measurement
 - VF tone generation and measurement
 - Timeslot activity monitor
 - Line rate offset
 - Frame data control and monitoring
 - Synchronization status messages
 - Built-in talk/listen capability
-

Contents

1 Getting Started

- Front Panel Features 1-2
- Initial Switch-on 1-3
- Navigating around the displays 1-3
- Choosing your HELP Language 1-3
- Setting the Date and Time 1-4
- Taking Care of your Battery 1-4
- Charging your Battery 1-4
- Verify Instrument Operation 1-5
- Performing Measurements with HP ProBER 2 1-5

2 Installation

- Initial Inspection 2-2
- Operating Environment 2-2
- Safety Precautions for the User 2-3
 - Safety Symbols 2-4
- Preparation for Use 2-5
 - Power Requirements 2-5
 - Connecting the dc Charger to the ac Power Supply 2-6
 - Connecting to the Network 2-7
- User's Maintenance 2-8
 - Cabinet Cleaning 2-8
 - Battery Replacement 2-8

3 Managing the Displays

- Accessing the Displays 3-2
- Navigating the Displays 3-3
- Modifying Display Data 3-4

Contents

LEDs 3-5

- Signal Loss LED 3-5
- Alarm LED 3-5
- Error LED 3-6
- History LED 3-6
- Low Battery LED 3-6
- Start/Stop LED 3-6
- dc In LED 3-6

4 Setting the Interfaces

- Connecting to the Network 4-2
- Setting Transmit and Receive Interfaces 4-3
- AutoSetup 4-5

5 Test Setup Features

- Adding Alarms or Errors 5-2
- Adding Frequency Offset 5-3
- Setting Signaling Bits 5-4
- Setting Spare Bits 5-5
- Setting Framing Bits 5-6
- Generating a VF Tone 5-7
- Configuring as a Telephone Handset 5-8
- Enabling DTMF Dialling 5-9

6 Making Measurements

- Setting Test Timing 6-2
- Measuring Errors and Alarms 6-4
- Measuring Error Analysis 6-6
- Performing a Trouble Scan 6-10
- Measuring Round Trip Delay 6-11
- Measuring Frequency and Frequency Offset 6-13
- Making Pulse Mask Measurements
(Option 001 only) 6-14
- Measuring Signal Level
(Option 001 only) 6-15

Contents

- Measuring Jitter 6-16
- Measuring a VF Tone (Using Channel Map) 6-18
- Monitoring Signaling Bits 6-20
- Monitoring Spare Bits 6-21
- Monitoring Framing Bits 6-22

7 Results

- Saving Graphs Results 7-2
- Recalling Graphs Results 7-3
- Viewing Graphs Results 7-4
- Logging Results to a Printer 7-5
- Connecting an HP 15730A/B Printer 7-7
- Printing a Display 7-8
- Logging Results to a PC 7-9

8 Using “Other” Features

- Setting Time and Date 8-2
- Storing and Titling Instrument Settings 8-3
- Recalling Instrument Settings 8-4
 - Instrument Reset (Cold Start) 8-4
- Setting Beep on Error/Alarm 8-5
- Setting Backlight Mode 8-6
- Setting Display Contrast 8-7
- Choosing Local Language Help Messages 8-8
- Charging the Battery 8-9
- Running Self Test 8-11

Getting Started

This chapter is intended to give first-time users a quick overview of the main features of HP ProBER 2. It is a repeat of the information in the Getting Started booklet, E7580-90013. Much of the information is repeated later in this manual, but in greater detail.

Getting Started

Front Panel Features

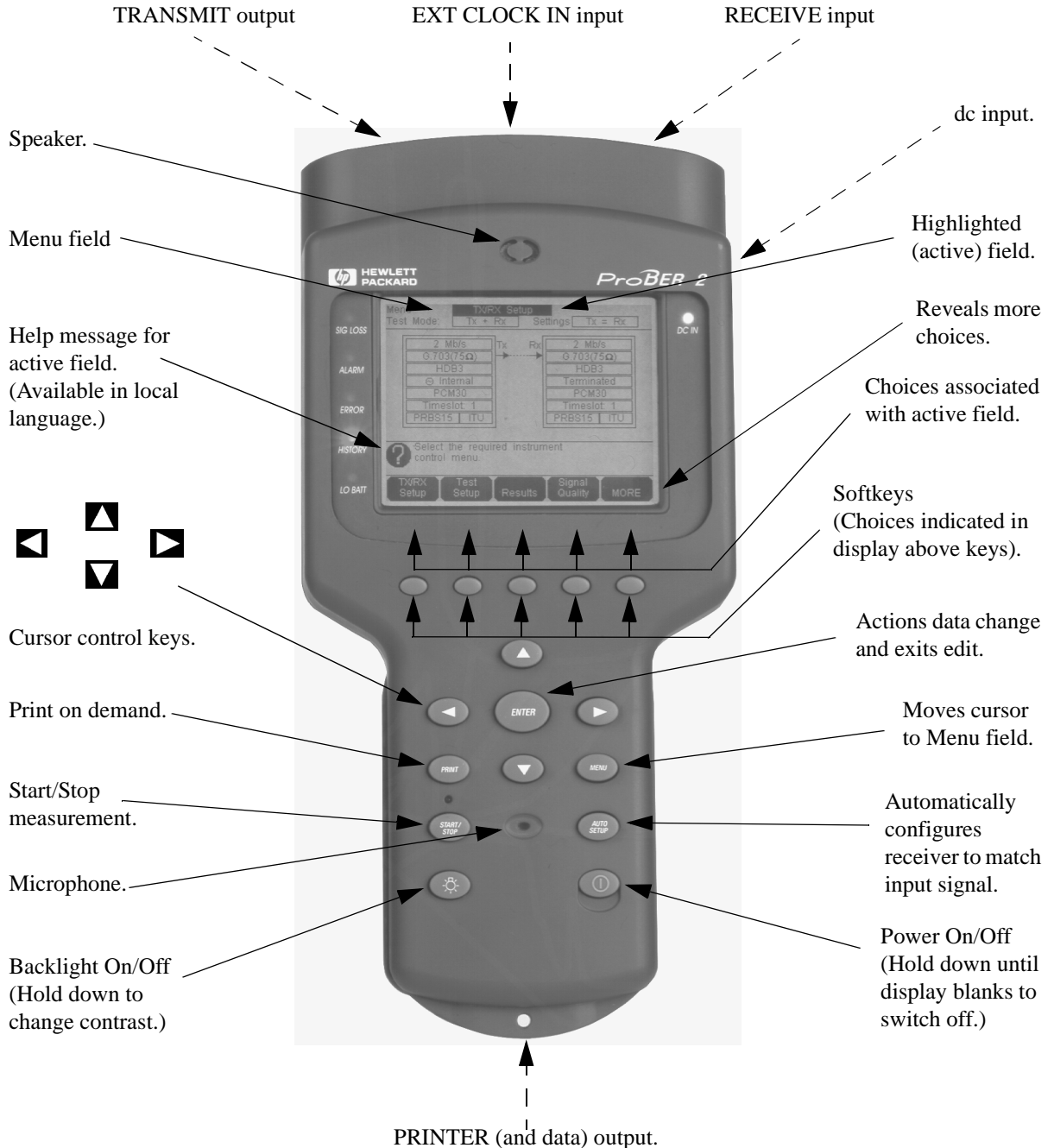

Getting Started





Initial Switch-on

HP ProBER 2 is supplied **ready to use** straight from the box. There is **no need to charge the battery**. Use the instrument until the battery is completely exhausted before giving it its first charge.

When you first switch on HP ProBER 2, you may need to **adjust the display contrast** by holding down the display backlight key . This cycles the contrast through its setting range. A quick press of the same key toggles the backlight on and off.

Navigating around the displays

Before using HP ProBER 2, you'll need to know how to select and change settings. Here's how to do that.

1. Move within the display area by using the cursor control keys , ,  and . Return the cursor to the top of the display quickly by pressing **MENU**.
2. In each of the display areas, the field that can be changed (the active field) is marked by a “highlighted cursor”. In the example shown here, it's **Tx + Rx**.
3. Alternative selections/modes for the active field are accessed using the softkeys below the display.
4. When a field has more than five choices, a softkey labelled **More** is provided. Press it to reveal more choices.

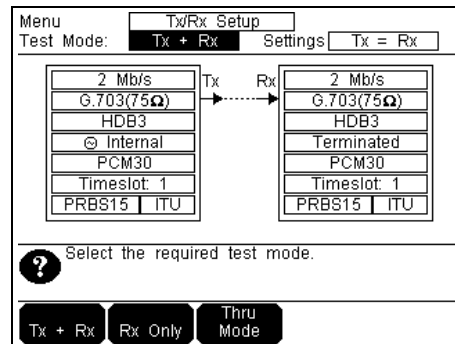

Choosing your HELP Language

The HELP messages displayed on the screen can be provided in English and one other language. The other language depends on which HP ProBER 2 option you have ordered.

1. Choose **MENU**, **More**, **Other**, , **More** then **Inst. Config** to obtain the local language display, as shown.
2. Move the cursor down to **Language** and choose the language required from the menu.

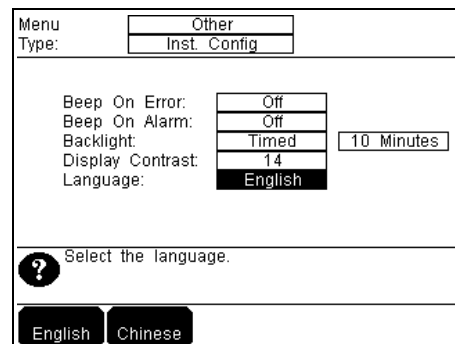

Getting Started

Setting the Date and Time

When results are recorded, it is useful to have certain events time-stamped, for example, Alarms, Error Seconds, etc. Here's how to set the date and clock:

1. Choose **MENU**, **More**, **Other**, **▼**, **More**, then **Time/Date** to obtain the Time and Date display, as shown.
2. Move the cursor to **Date** and enter the correct date using **EDIT**, **▲**, **▼**, **◀** and **▶**. Then press **ENTER** to action your edits or press **Cancel** to escape.
3. Move the cursor to **Time** and enter the correct time, as above.

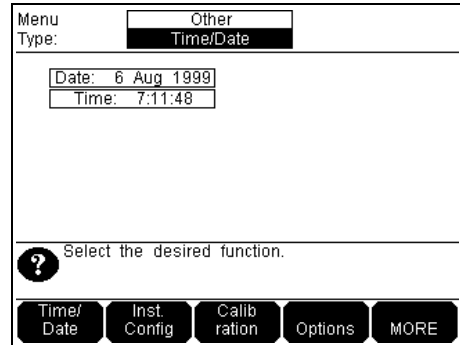

Taking Care of your Battery

HP ProBER 2 uses a high-performance Nickel Metal Hydride (NMH) rechargeable battery pack that may not be fully charged when you receive the instrument. Whatever the state of charge, use HP ProBER 2 until the battery is completely exhausted before being given its first charge. This ensures that the battery charge indicator is more accurate. Maximum accuracy is obtained after the battery has been fully discharged and recharged twice. Access the indicator by choosing **MENU**, **MORE**, **Other**, **▼** **Battery Life**. It takes a few minutes for the indicator to stabilize.

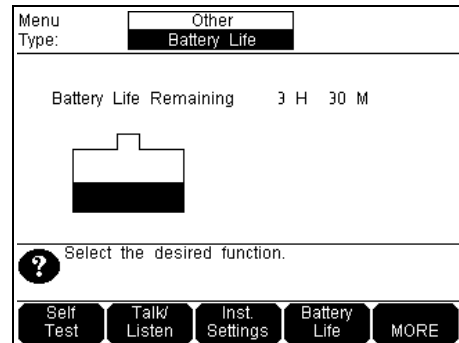

Charging your Battery

To recharge the battery, first fit the appropriate adapter (supplied) to the charger, as shown. Normally the battery will be fully charged after 5 hours.

Note that HP ProBER 2 can be used while the battery is charging.

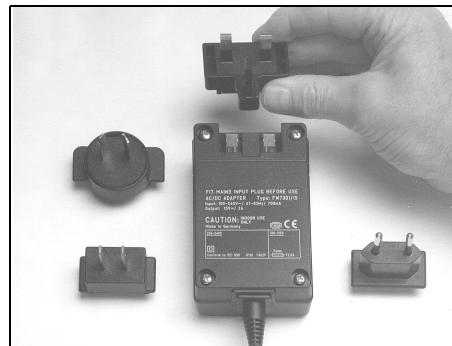

Verify Instrument Operation

Before making measurements, run a Self Test to check that HP ProBER 2 is operating correctly.

1. Choose **MENU**, **More**, **Other**, **Selftest**, **Quick Tests**.
2. Connect the TRANSMIT 75Ω port to the RECEIVE 75Ω port using the supplied cable.
3. Press **START/STOP** to run the self test. After a few seconds an **Overall Status** PASS or FAIL message will be displayed.
4. If the FAIL message is displayed, HP ProBER 2 should be returned to an HP Service Office for repair. For an up to date list of offices, see the HP Website at URL:
<http://www.tmo.hp.com/tmo/TMTop/English/index.html>

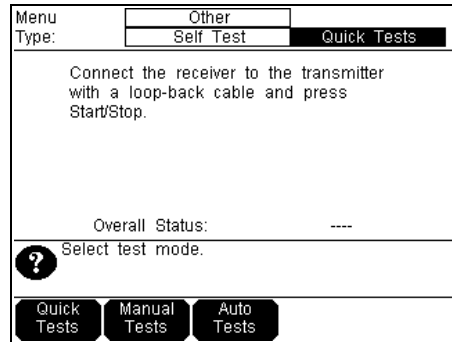

Performing Measurements with HP ProBER 2

You're now ready to perform measurements with HP ProBER 2. Full details of the measurements and how to perform them are in this User Reference Manual. The basic procedure is:

1. Select the test interface.
2. Set up the measurement parameters.
3. Perform the measurement.
4. Display or store the results.

The chapters in this User Reference Manual are set out in this order.

The Quick Reference Guide is a handy reminder of how to access the various measurements and features of HP ProBER 2.

The Service Manual includes procedures for verifying the performance as well as how to change the battery, should this be necessary.

Getting Started

Installation

First-time users, especially, should read this chapter before using HP ProBER 2. It contains information that must be followed to ensure the safety of the operator and the long life of the instrument.

Installation

Initial Inspection

WARNING

TO AVOID HAZARDOUS ELECTRICAL SHOCK, DO NOT PERFORM ELECTRICAL TESTS WHEN THERE ARE SIGNS OF SHIPPING DAMAGE TO ANY PORTION OF THE OUTER ENCLOSURE (COVERS, PANELS, METERS).

Inspect the shipping container for damage. If the shipping container or cushioning material is damaged, it should be kept until the contents of the shipment have been checked for completeness and the instrument has been checked both mechanically and electrically. Procedures for checking electrical operation are given in the Service Manual. If the contents of the shipment are incomplete or if there is mechanical damage or defect, notify the nearest Hewlett-Packard office. If the instrument does not pass the electrical performance tests given in the Service Manual, notify the nearest Hewlett-Packard office. If the shipping container is also damaged, or the cushioning material shows signs of stress, notify the carrier as well as the nearest Hewlett-Packard office. Keep the shipping materials for the carrier's inspection. The Hewlett-Packard office will arrange for repair or replacement without waiting for claim settlement.

A list of Hewlett-Packard Sales and Service Offices is available through the HP Website at URL:

<http://www.tmo.hp.com/tmo/TMTop/English/index.html>

Operating Environment

This instrument is designed for *Indoor* use only.

DO NOT operate the product in an explosive atmosphere or in the presence of flammable gasses or fumes.

This instrument may be operated in environments within the following limits:

Temperature: 0°C to +50°C (operating);
0°C to +40°C (charging).

Altitude: Up to 3050 m (10,000 ft)

Installation

Humidity: Up to 95% relative humidity to 40°C, but it should be protected from temperature extremes which may cause condensation.

CAUTION

This instrument is designed for use in Installation Category II and Pollution Degree 2 per IEC 1010 and 644 respectively.

CAUTION

This instrument has an external dc charger unit which has an autoranging line voltage input. Ensure the line supply is within the range 100 to 240 V ac.

Safety Precautions for the User

The following general safety precautions must be observed during all phases of operation, service, and repair of this instrument. Failure to comply with these precautions or with specific warnings elsewhere in this manual violates safety standards of design, manufacture, and intended use of the instrument. Hewlett-Packard Company assumes no liability for the customer's failure to comply with these requirements.

In particular, the operator should note the following safety information:

- "Safety Symbols" on page 2-4.
- "Connecting the dc Charger to the ac Power Supply" on page 2-6.
- "Operating Environment" on page 2-2.
- "Battery Replacement" on page 2-6.
- "User's Maintenance" on page 2-8.

DO NOT operate damaged equipment: Whenever it is possible that the safety protection features built into this product have been impaired, either through physical damage, excessive moisture, or any other reason, REMOVE POWER and do not use the product until safe operation can be verified by service-trained personnel. If necessary, return the product to a Hewlett-Packard Sales and Service Office for service and repair to ensure the safety features are maintained.

Installation

Safety Symbols

The following symbols on the instrument and in the manual indicate precautions which must be taken to maintain safe operation of the instrument



The product is marked with this symbol when it is necessary for the user to refer to the instructions in the supplied documentation.



Indicates the field wiring terminal that must be connected to earth ground before operating the equipment - protects against electrical shock in case of fault.

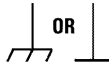

Frame or chassis ground terminal - typically connects to the equipment's metal frame.



Alternating current (ac)



Direct current (dc)



Indicates hazardous voltages



Equipment protected throughout by Double Insulation or Reinforced Insulation, equivalent to Class II of IEC 536.

WARNING

Warning denotes a hazard. It calls attention to a procedure, which if not correctly performed or adhered to could result in injury or loss of life. Do not proceed beyond a warning until the indicated conditions are fully understood and met.

CAUTION

Caution denotes a hazard. It calls attention to a procedure, which if not correctly performed or adhered to could result in damage to or destruction of the instrument. Do not proceed beyond a caution until the indicated conditions are fully understood and met.

Preparation for Use

WARNING

If this instrument is not used as specified, the protection provided by the equipment could be impaired. This instrument must be used in a normal condition only (in which all means for protection are intact).

Power Requirements

HP ProBER 2 is powered from an internal 7.2 V dc battery or from an external 15 V dc charger unit. The external charger requires a power source of 100 to 240 V ac at a frequency between 47 and 63 Hz (nominal).

Total power consumption of HP ProBER 2 is 22.5 VA (maximum).

Battery Power

The rechargeable battery (Part No. E7580-60010) will typically power HP ProBER 2 for more than 8 hours with the backlight off and Bit Error measurement mode selected.

Charging the Battery

HP ProBER 2 uses a high-performance Nickel Metal Hydride (NMH) rechargeable battery that may not be fully charged when you receive the instrument. Whatever the state of charge, use HP ProBER 2 until the battery is completely exhausted before giving it its first charge. This will ensure better accuracy from the battery charge indicator, see “Charging the Battery” on page 8-9.

To recharge the battery, plug in the charger using the appropriate adapter (supplied). Normally the battery will be fully charged after 5 hours. In exceptional circumstances where the battery may have become deeply discharged, a charge time of 24 hours may be required. Note that HP ProBER 2 can be used while the battery is charging.

Installation

dc Connector Polarity

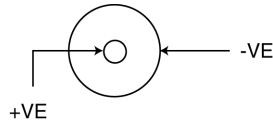

Battery Replacement

Refer to the instructions in the Repair section of the Service Manual for details of how to replace the battery.

WARNING



**CONTAINS NICKEL METAL
HYDRIDE. BATTERY MUST BE
RECYCLED OR DISPOSED OF
PROPERLY.**

Connecting the dc Charger to the ac Power Supply

Power Cord

The universal dc charger comes with a choice of power connectors as shown in the drawing below. Choose the connector appropriate for the country of use and slide it into the body of the charger, as shown in “Charging your Battery” on page 1-4. Your charger is now ready for use.

Available ac Power Connectors Configurations

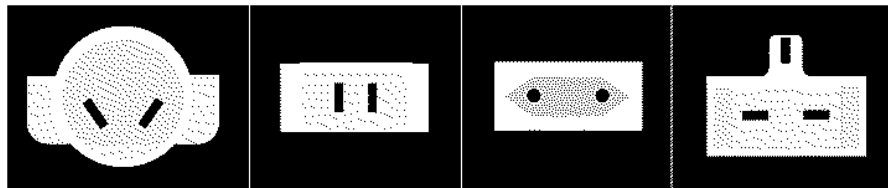

Installation

Connecting to the Network

The network connectors are located at the top of the instrument.

CAUTION

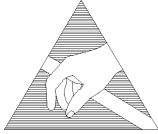

When connecting or disconnecting HP ProBER 2, ensure that you are grounded to bring you and the instrument to the same static potential.

75Ω RECEIVE

Receiver input interface. Allows the connection of 75Ω unbalanced data signals.

75Ω TRANSMIT

Transmitter output interface. Provides 75Ω unbalanced data output.

120Ω RECEIVE

Receiver input interface. Allows the connection of 120Ω balanced data signals.

120Ω TRANSMIT

Transmitter output interface. Provides 120Ω balanced data output.

EXT CLOCK IN

Allows connection of a 75Ω timing reference as per CCITT G.811. The reference format may be either clock or data.

RS232 PRINTER

External printer connection details are given in "Connecting an HP 15730A/B Printer" on page 7-7.

Installation

User's Maintenance

Maintenance appropriate for the user is:

- Cabinet cleaning.
- Battery replacement.

Cabinet Cleaning

Clean the cover using a damp cloth only.

Battery Replacement

Refer to the instructions in the Repair section of the Service Manual for details of how to replace the battery.

WARNING

No user serviceable parts inside. Refer servicing to qualified personnel.

Managing the Displays

Find out how to navigate the displays and modify display data by reading this chapter.

Managing the Displays





Accessing the Displays

Accessing the Displays

The user interface is provided by the display softkeys and the front panel keys.

The softkeys provide access to seven different instrument setup areas:

TX/RX Setup	Allows control of the main Transmit and Receive settings.
Test Setup	Allows control of the test features: Errors & Alarms, Frequency Offset, Channel Associated Signaling Setup, VF Tone Transmission, DTMF Dialling, Frame Control and Spare Bit Setup.
Results	Allows control of the Test timing and displays the selected measurement results.
Signal Quality	Allows control of Jitter measurements and displays received frequency offset, level, pulse mask and jitter results.
Graphs	Displays the stored graphical results.
Log/Print	Allows control of logging results to the external printer.
Other	Allows control of Time & Date, Talk/Listen, Calibration, Self Test, Instrument Settings, Beep on Error, Beep on Alarm, Backlight Mode, Display Contrast, Language and Battery Life. A list of the Options fitted can also displayed.

To move within the display areas use the cursor control keys , ,  and . To return quickly to the top of the display, press **MENU**.

Managing the Displays

Navigating the Displays

Navigating the Displays

- 1 In each of the display areas the field currently able to be changed is marked by a “highlighted cursor”. In the display shown below, the highlighted cursor is **Tx + Rx**.

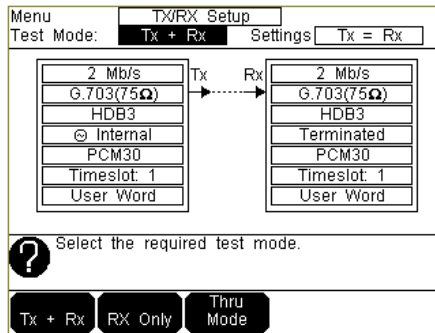

- 2 The menu of selections available for the active field is displayed on softkeys at the bottom of the display. The choice from the menu is made using the keys situated immediately below the display.
- 3 The highlighted cursor is moved around the display using **▼**, **▲**, **◀** and **▶** or can be quickly returned to the top of the display by pressing **MENU**.

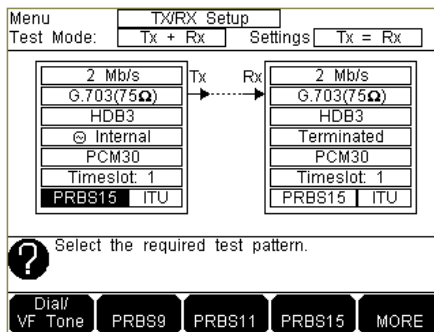

- 4 When a field has more than five choices a softkey labelled **MORE** is provided. When **MORE** is chosen the remainder of the menu is revealed.

Managing the Displays

Modifying Display Data

Modifying Display Data

Display data is modified using **▼ ▲ ◀ ▶**, the display softkeys, **ENTER** and **Cancel**.

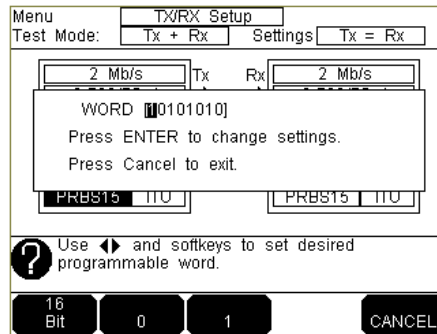

- 1 In the USER WORD example **◀** and **▶** move the cursor to the bit to be edited.
8 Bit and **16 Bit** allows you to change the Word length.
0 and **1** change the value of the chosen bit.
ENTER actions the changes and exits the edit.
Cancel allows you to exit the edit without change.

Managing the Displays

LEDs

LEDs

There are seven LEDs on HP ProBER 2. The significance of each is described here.

Signal Loss

Alarm

Error

History

Low Battery

dc In

Start/Stop



Signal Loss LED

When this LED is lit, it indicates that no data transitions are present at the Receive Input. In other words, there is a loss of signal.

Alarm LED

When lit, this LED indicates that an alarm condition exists.

Managing the Displays

LEDs

Error LED

This LED is lit when an error has been detected.

History LED

When lit, this LED indicates that an alarm or error has been detected. When the alarm or error has occurred during a measurement period controlled by the **START/STOP** key, the cause of it being lit can be determined by looking at the Results page of the display. The LED is reset when a measurement gating period is started.

Low Battery LED

When this LED is lit, the battery requires charging. To see the precise battery capacity remaining, press **MENU**, **MORE**, **Other** and **Battery Life**. Wait for approximately 3 minutes for the charge level indicator to stabilize. See "Charging the Battery" on page 8-9 for more information.

Start/Stop LED

This green LED is lit during a measurement gating period. Note that it takes approximately one second for the LED to go out after pressing the **START/STOP** key.

dc In LED

This LED is lit when HP ProBER 2 is operating from the dc power supply provided by the charger unit and the battery is being charged.

Setting the Interfaces

This is the first step in using HP ProBER 2 - connecting to the network and setting up the transmitter and receiver.

Setting the Interfaces

Connecting to the Network

Connecting to the Network

Description:

HP ProBER 2 provides 75Ω unbalanced and 120Ω balanced transmit and receive interfaces. For details of the connectors, see “Connecting to the Network” on page 2-7.

NOTE

To prevent distortion of the results only connect cables to one of the Transmit or Receive ports i.e. 75Ω or 120Ω.

The receive interface termination can be:

Terminated - 0 dB Gain

Monitor 20 dB Gain - to compensate for a low level signal at a network equipment monitor point.

Monitor 26 dB Gain - to compensate for a low level signal at a network equipment monitor point.

Monitor 30 dB Gain - to compensate for a low level signal at a network equipment monitor point.

Bridged - high impedance.

HP ProBER 2 also provides a 75Ω EXT CLOCK IN port which accepts a 2 MHz clock source complying with ITU-T G.703 Section 10 (Reference 1).

HOW TO:

- 1 Choose **MENU** **TX/RX Setup** to obtain the Transmit and Receive interface display. Scroll down to select the receive interface termination, as shown.

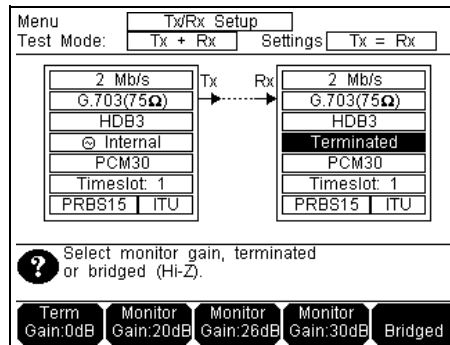

Setting the Interfaces

Setting Transmit and Receive Interfaces

Setting Transmit and Receive Interfaces

Description:

HP ProBER 2 can be configured to:

Transmit and Receive simultaneously,

Operate in Receive Only mode or

Operate in Thru Mode.

Thru Mode allows non-intrusive monitoring of live traffic.

NOTE

Receive Only mode extends the time between battery charges.

HOW TO:

- 1 Choose **MENU** **TX/RX Setup** to obtain the Transmit and Receive interface display, as shown.

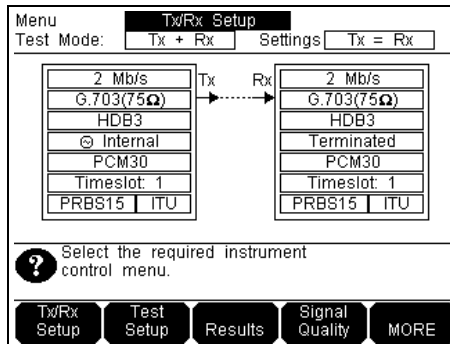

- 2 Press **▼** then choose your operating mode from **Tx + Rx**, **Rx Only** or **Thru Mode**.

If **Tx + Rx** is chosen the Transmit and Receive settings can be coupled together or independent of each other:

Tx = Rx - any change on either Tx or Rx will automatically occur on the other.

Tx ≠ Rx - changes to Tx and Rx settings must be made independently of each other.

If **Rx Only** is chosen only the Receive settings are available.

If **Thru Mode** is chosen the received signal can be:

Transparent - returned to the network without being modified.

Overwrite - modified before return to the network

Setting the Interfaces

Setting Transmit and Receive Interfaces

NOTE

In **Overwrite** mode, timeslots not selected are passed through unmodified. When **Timeslot: None** is selected, changes to the frame structure are permitted without changing any of the timeslot data.

Tx/Rx Parameters:

Tx	Rx
Line Rate	Line Rate
Line Impedance	Line Impedance
Line Code	Line Code
Clock Source	Termination
Frame Type	Frame Type
Timeslot	Timeslot
Test Pattern	Test Pattern

- 3 Now choose the rest of the Tx and/or Rx Interface parameters, in turn. A menu of the parameters is shown in the table to the left.
- 4 Choose the Line Rate required.
If Option 002, Co-directional Interface, is fitted **64 kb/s** is added to the menu.
- 5 Choose the Line Impedance required. If Line Rate **64 kb/s** (Option 002 only) is chosen, only **G703 (120Ω)** is available.
- 6 Choose the Line Code. The Line Code is set to co-directional if Line Rate **64 kb/s** is chosen.
- 7 Choose the Clock Source required. If **External** is chosen, a 2 MHz clock complying with ITU-T G.703 Section 10 (Reference 1) must be connected to the 75Ω **EXT CLOCK IN** port, even if Line Rate **64 kb/s** is selected.
- 8 If Line Rate **64 kb/s** is chosen choose the OCTET state.
- 9 If Line Rate **2 Mb/s** is chosen, choose the Frame Structure.
- 10 If any Frame Structure other than **Unframed** is selected, choose the test Timeslots.
Use **▲** and **▼** to select a single timeslot or use **Edit**, **▼**, **▲**, **◀**, **▶**, and **Select/Delete**, **Select/Delete All**, **◀◀** and **▶▶** to select single or multiple timeslots.
Press **ENTER** to action your edits or press **Cancel** to escape.
- 11 Choose a test PRBS/Word Pattern or a test VF Tone. The Tx and Rx test patterns are coupled. A change on one will occur on the other except when **Live** is chosen as the Receive pattern.
If **Live** is chosen as the Receive pattern then bit error measurements are disabled.
If **User Word** is chosen use **User Word 8 BIT**, **16 BIT**, **0** and **1** to set the user word value.
Press **ENTER** to action your edits or press **Cancel** to escape.
If **Dial/VF Tone** is chosen, see “Generating a VF Tone” on page 5-7.

Setting the Interfaces

AutoSetup

AutoSetup

Description:

HP ProBER 2 can be configured to match the received signal using the **AUTOSETUP** feature.

When **AUTOSETUP** is pressed, HP ProBER 2 will monitor the received signal to detect the line rate. If 2.048 Mb/s or 64 kb/s is not detected, AutoSetup will halt and Signal Loss will be indicated.

If 2.048 Mb/s or 64 kb/s is detected, HP ProBER 2 will attempt to match the framing present on the received signal. If PCM30, PCM31, PCM30CRC or PCM31CRC is not detected, it will be assumed the received signal is Unframed.

HP ProBER 2 will next check for a valid test pattern in the received signal.

If a valid test pattern is not detected, the Line Rate and Framing settings will be retained.

NOTE

1. If a measurement is running under the control of Test Timing, this must be halted by pressing **START/STOP** before AutoSetup can be used.
 2. If AutoSetup is running and you wish to make a measurement under the control of Test Timing, AutoSetup must be halted by pressing **AUTOSETUP**.
 3. If HP ProBER 2 does not find a recognizable test pattern distributed across all the timeslots in a 2 Mb/s signal, it will terminate its search.
-

Test Setup Features

Now that you've set up the interfaces (see Chapter 4), you are ready for the second stage - setting the measurement conditions, such as adding alarms, setting signaling bits or generating a VF tone.

Test Setup Features

Adding Alarms or Errors

Adding Alarms or Errors

Description:

Alarms or errors can be added to the transmit signal during testing. An indication of received alarms and errors is displayed.

The following alarms or errors can be added:

- **Alarms** - LOS (loss of signal), AIS (alarm indication signal), LOF (loss of frame), Timeslot AIS, RDI (remote defect indication), RDI MF (multiframe).
- **Errors** - Bit, Code, FAS (frame alignment signal), CRC (cyclic redundancy check), E-bit.

Bit, Code, CRC and E-bit errors can be added singly or at one of the predetermined error rates in the range 1 in 10^3 to 1 in 10^7 . FAS errors can be added at 1 in 4, 2 in 4, 3 in 4 and 4 in 4 (all).

NOTE

If Option 001, Advanced Signal Quality Measurements, is fitted and Jitter is enabled, Error Add is disabled but Alarm Add is available.

HOW TO:

- 1 Choose **MENU**, **Test Setup**, **▼**, **Alarm/Error** to obtain the Alarm or Error Add display, as shown.

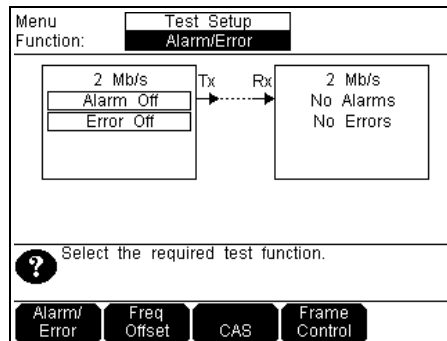

- 2 Choose the **Alarm Type**.
- 3 Choose the **Error Add Type** and **Rate** required. Note that Errors and Alarms can be added to the transmit signal at the same time.

Test Setup Features

Adding Frequency Offset

Adding Frequency Offset

Description:

The capability of the network equipment to reliably recover the clock is tested by varying the clock rate of the generated data and checking for errors.

The measurement can be made in a loopback or a cross multiplexer configuration, and is generally of short duration.

Frequency Offset can only be added to the generated 2 Mb/s signal if Clock Source **Internal** is chosen.

Frequency Offset can be added at:

- Preset ITU values - **+50ppm** and **-50ppm**
- User defined values in the range ± 100 ppm.

HOW TO:

- 1 First choose Clock Source **Internal** on the **TX/RX Setup** display. Then press **[MENU]**, **Test Setup**, **[▼]**, **Freq Offset** to prepare to add Frequency Offset, as shown.

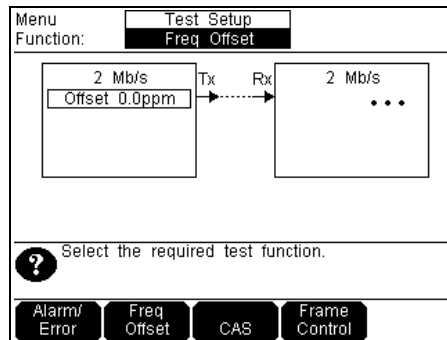

- 2 Choose the amount of Frequency offset required from the menu. If you wish to add frequency offset at other than the preset values, use **Edit**, **[◀]**, **[▶]**, **[▼]** and **[▲]** to choose the amount of frequency offset. Press **[ENTER]** to action your edits or press **Cancel** to escape.

NOTE

The Frequency of the received signal and the Frequency Offset present on the received signal are also displayed on the **[MENU]**, **Signal Quality**, **Freq** display.

Test Setup Features

Setting Signaling Bits

Setting Signaling Bits

Description:

Channel Associated Signaling (CAS) is transmitted in Timeslot 16 when **PCM30** or **PCM30CRC** framing is chosen on the **TX/RX Setup** display. CAS provides the information necessary for switching and routing all 30 timeslots.

The ability to set the value of the CAS bits allows testing of the routing and switching of any or all of the timeslots.

HOW TO:

- 1 Choose **MENU**, **Test Setup**, **▼**, **CAS** to obtain the Channel Associated Signaling setup display.
- 2 Use the cursor keys **▼**, **▲**, **◀** and **▶**, and the softkeys **0** and **1** to set the value of the CAS signaling bits, as shown.

Menu		Test Setup					
Function:		CAS					
TS	ABCD	TS	ABCD	TS	ABCD	TS	ABCD
1	1010	9	1010	17	1010	25	1010
2	1010	10	1010	18	1010	26	1010
3	1010	11	1010	19	1010	27	1010
4	1010	12	1010	20	1010	28	1010
5	1010	13	1010	21	1010	29	1010
6	1010	14	1010	22	1010	30	1010
7	1010	15	1010	23	1010	31	1010
8	1010			24	1010		

? Use cursor and softkeys to modify ABCD bits.

1 0

Test Setup Features

Setting Spare Bits

Setting Spare Bits

Description:

With **PCM30CRC** or **PCM31CRC** framing, spare bits Sa4 to Sa8 can be used to send optional network messages, for example a Synchronization Status Message.

HOW TO:

- 1 Choose **MENU**, **Test Setup**, **▼**, **Sa Bit Control** to obtain the Spare Bit setup display, as shown.

The screenshot shows a menu interface for 'Sa Bit Control'. At the top, the 'Menu' is 'Test Setup' and the 'Function' is 'Sa Bit Control'. Below this, the 'Sync. Message' is set to 'Sa4' with a 'Quality Unknown' indicator. A table displays the bit values for Sa4 through Sa8, with columns for SMF1 and SMF2. All values are currently '0000'. At the bottom, there is a question mark icon and the instruction 'Select Sa bit to carry Synchronisation Status Message.' Below the instruction are five buttons: 'Off', 'Sa4', 'Sa5', 'Sa6', and 'MORE'.

	SMF1	SMF2
Sa4	0000	0000
Sa5	0000	0000
Sa6	0000	0000
Sa7	0000	0000
Sa8	0000	0000

Synchronization Status Message

- 2 Choose the Sa bit in which the Sync Message is to be inserted.
Choose the Sync Message to be inserted.

Bit Value

- 3 Use the cursor keys **▼**, **▲**, **◀** and **▶**, and the softkeys **0** and **1** to set the spare bit value.

Test Setup Features

Setting Framing Bits

Setting Framing Bits

Description:

When **PCM30** or **PCM30CRC** framing is chosen, the Multiframe Alignment Signal (MFAS) provides synchronization of the signaling multiframe.

When **PCM30CRC** or **PCM31CRC** framing is chosen, a CRC-4 Multiframe is formed. CRC MFAS provides synchronization of the CRC-4 Multiframe.

On the **Frame Control** display, the following frame bits can be set:

- **PCM30** - Si-bits, Sa4 - Sa8, MFAS, X-bits
- **PCM30CRC** - MFAS, X-bits, CRC MFAS
- **PCM31** - Si-bits, Sa4 - Sa8
- **PCM31CRC** - CRC MFAS

HOW TO:

- 1 Choose **MENU**, **Test Setup**, **▼**, **Frame Control** to obtain the Frame Control display.
- 2 Use the cursor keys **▼**, **▲**, **◀** and **▶**, and the softkeys **0** and **1** to set the required bit values, as shown.

Menu	Test Setup
Function:	Frame Control
Timeslot-0 (FAS)	Si FAS 1 0011011
Timeslot-0 (NFAS)	Si A Sa4-Sa8 1110 11111
Timeslot-16 (Frame-0)	MFAS xyxx 0000 1011
? Edit bit field.	
1 0	

Test Setup Features

Generating a VF Tone

Generating a VF Tone

Description:

Telephone channels can be verified by inserting a Voice Frequency Tone at the transmitter. The tone should be verified in both level and frequency at the receiver.

NOTE

1. The VF tone feature is only offered when both Tx and Rx are selected for single timeslot operation.
2. VF tone is not offered whilst Jitter measurement is enabled.

HOW TO:

- 1 On the **MENU**, **TX/RX Setup** display, select **Dial/VF Tone** as the Test Pattern. Then choose **MENU**, **Test Setup**, **▼**, **VF Tone** to obtain the VF Tone test display, as shown.

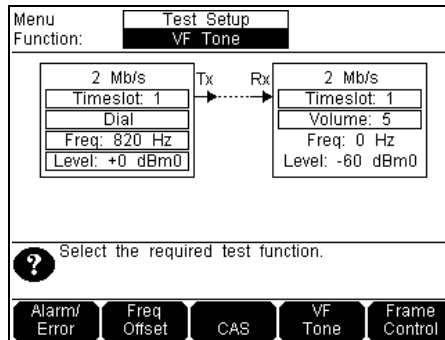

- 2 Choose the timeslot in which you wish to insert the VF Tone. Use **▲** and **▼** to select a single timeslot or use **Edit**, **▼**, **▲**, **◀**, **▶**, **Select/Delete**, and **Select/Delete All** to select single or multiple timeslots. Press **ENTER** to action your edits or press **Cancel** to escape.
- 3 If required, choose **Dial** to enter a phone number for dialling. Use **◀**, **▶**, **▼**, **▲**, **INS** and **DEL** to enter the phone number. Press **ENTER** to dial the number or press **Cancel** to escape.
- 4 Choose a preset tone frequency or make your own choice using **Edit**, **◀**, **▶**, **▼** and **▲**. Press **ENTER** to action your edits or press **Cancel** to escape.
- 5 Use **Edit**, **◀**, **▶**, **▼** and **▲** to choose the tone level. Press **ENTER** to action your edits or press **Cancel** to escape.
- 6 Adjust the loudspeaker volume if required using **▲** and **▼**.

Test Setup Features

Configuring as a Telephone Handset

Configuring as a Telephone Handset

Description:

You can use HP ProBER 2 as a telephone handset by talking into the built-in microphone and listening to the built-in loudspeaker. It can be connected to a 64 kb/s voice channel (Timeslot) for communication purposes.

HOW TO:

- 1 Choose **MENU**, **MORE**, **Other**, **▼**, **Talk/Listen**, **▶**, **Enabled** to obtain the Talk/Listen display, as shown.

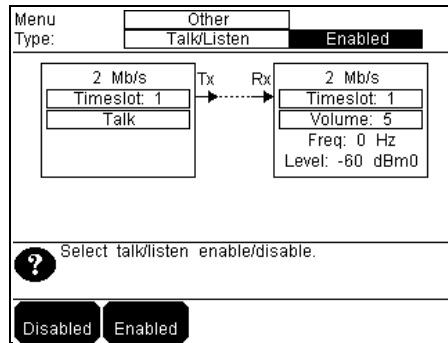

- 2 Choose the timeslot (voice channel) in which you wish to communicate. Use **▲** and **▼** to select a single timeslot or use **Edit**, **▼▲◀▶**, and **Select/Delete**, **Select All**, **Clear All** to select single or multiple timeslots. Press **ENTER** to action your edits. Press **Cancel** to escape.
- 3 If required choose **DTMF Dialling** to enter a phone number for dialling. Use **INS** and **DEL** to set the number of digits in the phone number. Use **◀▶▼▲**, **INS** and **DEL** to enter the phone number. Press **ENTER** to dial the number. Press **Cancel** to escape.
- 4 Adjust the loudspeaker volume as required using the **▲** and **▼** softkeys.

Test Setup Features

Enabling DTMF Dialling

Enabling DTMF Dialling

Description:

DTMF Dialling allows dialling of phone numbers to establish a communications or test channel.

HOW TO:

- 1 Access the display via Talk/Listen or VF Tone as follows:

Via Talk/Listen

Choose **MENU**, **MORE**, **Other**, **▼**, **Talk/Listen**, **▶**, **Enabled** and move the cursor to **Talk**, as shown. Then choose **DTMF Dialling** to obtain the DTMF Dialling display.

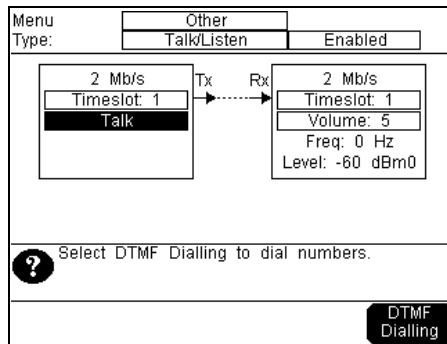

Via VF Tone

On the **MENU**, **TX/RX Setup** display, select **Dial/VF Tone** as the Test Pattern. Then choose **MENU**, **Test Setup**, **▼**, **VF Tone** and move the cursor to **Dial**, as shown. Then choose **Dial** to obtain the DTMF Dialling display.

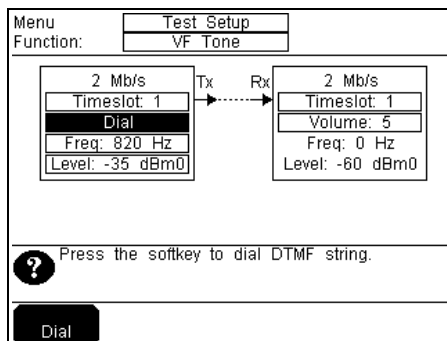

Test Setup Features

Enabling DTMF Dialling

- 2 Enter the phone number to be dialled
 - Use **INS** and **DEL** to set the number of digits in the phone number.
 - Use **◀**, **▶**, **▼**, **▲**, **INS** and **DEL** to enter the phone number.
 - Press **ENTER** to dial the number. Press **Cancel** to escape.
 - The status message *“Dialling DTMF Number Now”* is displayed in the Help window during dialling.

Making Measurements

This chapter tells you how to perform measurements with HP ProBER 2 once you have set up the interfaces, see Chapter 4, and measurement conditions, see Chapter 5.

Making Measurements

Setting Test Timing

Setting Test Timing

Description:

The test measurement period may be:

- **Manual** - Started and stopped by pressing **START/STOP**.
- **Single** - Set to a predetermined duration. Started by **START/STOP** and stopped automatically at the end of the timed period.
- **Delayed** - Set to a predetermined duration. Started automatically at the programmed date and Time and stopped automatically at the end of the timed period.

The test duration can be a preset period of 10 seconds, 1 minute, 15 minutes or 1 hour, or a user-defined period up to 99 days, 23 hours, 59 minutes and 59 seconds.

NOTE

Test durations greater than 8 hours are only possible if HP ProBER 2 is connected to the line supply via the dc charger.

While the measurement is running the elapsed test time is displayed at the bottom right of the **Results** display.

HOW TO:

- 1 Choose **MENU**, **Results**, **▼**, **Test Timing** to obtain the Test Timing display.
- 2 Select the **Test Type** you require, as shown.

Menu	Results
Type:	Test Timing
Test Type	Delayed
Duration	10 Seconds
Start	27-Jul-1999 9:51
	00:00:00:00
? Select the test type.	
Manual	Single Delayed

- 3 If **Manual** is chosen, the test must be started and stopped by pressing **START/STOP**.

Making Measurements

Setting Test Timing

- 4 If **Single** is selected, move the cursor to **Duration** and choose a preset measurement period or your own measurement period.

To choose your own measurement period use **User**, **◀**, **▶**, **▼** and **▲**.

Press **ENTER** to action your edits or press **Cancel** to escape.

Press **START/STOP** to start the test.

Press **START/STOP** again if you wish to stop the test before the measurement period has finished.

- 5 If **Delayed** is selected, move the cursor to **Duration** and choose a preset measurement period or your own measurement period.

To choose your own measurement period use **User**, **◀**, **▶**, **▼** and **▲**.

Press **ENTER** to action your edits or press **Cancel** to escape.

Move the cursor to **Start** and set the start date using **Edit**, **◀**, **▶**, **▼** and **▲**.

Press **ENTER** to action your edits or press **Cancel** to escape.

Move the cursor to **Time** and enter the start time using **Edit**, **◀**, **▶**, **▼** and **▲**.

Press **ENTER** to action your edits or press **Cancel** to escape.

The test will start when the start date and start time are reached.

Once the measurement has started, press **START/STOP** if you wish to stop the test before the measurement period has finished.

If you press **START/STOP** before the delayed measurement period has started, HP ProBER 2 will start a measurement period using the duration as previously set for the delayed measurement.

Making Measurements

Measuring Errors and Alarms

Measuring Errors and Alarms

Description:

Error Count, Error Ratio and Errored Second results are available for each of the following error sources:

- Bit
- Code
- FAS
- CRC
- E-Bit

A summary of the results is available and provides an Error Count, Error Ratio and Errored Seconds for each of these error sources plus an Alarm Seconds Count. The following Alarm Seconds Results are available:

- LOS (Loss of Signal)
- AIS (Alarm Indication Signal)
- LOF (Loss of Frame)
- TS AIS (Timeslot AIS)
- CAS MF Loss (CAS Multiframe Loss)
- Pattern Loss
- RDI (Remote Defect Indication)
- RDI MF (Multiframe Remote Defect Indication)

For more information, see “Adding Alarms or Errors” on page 5-2.

HOW TO:

- 1 Set up the transmit and receive interfaces. See “Setting Transmit and Receive Interfaces” on page 4-3.
- 2 Choose the Test Timing required (see “Setting Test Timing” on page 6-2) and start the test by pressing **START/STOP**.
- 3 Choose **MENU**, **Results**, **▼**, **Errors+Alarms** to obtain the Error and Alarm Results display, as shown opposite.
- 4 Choose the error summary, individual error results (Bit, Code, FAS, CRC or E-bit) or alarm seconds results for viewing.
Any of the other results can be viewed without affecting the measurement.

Making Measurements

Measuring Errors and Alarms

Menu	Results	
Type:	Errors+Alarms	Bit
	Total	Current
Count	0	0
Ratio	0	0
ESecs	0	-
		00:00:00:00
	Select the type of results to be displayed.	
Summary	Bit	Code FAS MORE

Note that the frame structure chosen when setting up the transmit and receive interfaces affects which of the individual error results (Bit, Code, FAS, CRC or E-bit) are available for viewing, as shown in the table below.

Frame structure	Error source				
	Bit	Code	FAS	CRC	E-bit
PCM30	•	•	•		
PCM30CRC	•	•	•	•	•
PCM31	•	•	•		
PCM31CRC	•	•	•	•	•
Unframed	•	•			

Making Measurements

Measuring Error Analysis

Measuring Error Analysis

Description:

Analysis results conforming to G.821 and G.826 are provided. For Option 003 only, analysis results conforming to M.2100, M.2110 and M.2120 are also provided.

G.821

Count and Ratio results of Errored Seconds (ES), Error Free Seconds (EFS), Severely Errored Seconds (SES), Degraded Minutes (DM) and Unavailable Seconds (UAS) are displayed for the following error sources:

- Bit
- FAS
- CRC
- E-Bit

In addition, an Annex D Errored Seconds ratio (when an unframed frame structure is chosen on the **TX/RX Setup** display), a Code Error Seconds count and a Pass/Fail result are displayed.

G.826

In-service, Near End and Far End results of Errored Blocks (EB), Background Block Error (BBE), Errored Seconds (ES), Severely Errored Seconds (SES), Unavailable Seconds (UAS) and a Pass/Fail result are displayed.

In addition, out-of-service results of Errored Blocks (EB), Background Block Error (BBE), Errored Seconds (ES), Severely Errored Seconds (SES), Unavailable Seconds (UAS) and a Pass/Fail result are displayed.

Path Allocation

The Pass/Fail result is based on preset threshold settings. If a threshold is exceeded, a FAIL result is displayed.

When measuring over a part of a path the Pass/Fail thresholds need to be reduced according to the percentage of the path being measured.

The path allocation percentage reduces the threshold on a pro-rata basis.

The following Pass/Fail thresholds apply to a path allocation of 100%:

- G.821 - ESR <0.08, SESR < 0.002
- G.826 - ESR <0.04, SESR <0.002, BBER 2×10^{-4}

Making Measurements

Measuring Error Analysis

In-service G.826 analysis allows setting a Path Unavailable Seconds (PUAS) threshold. If the threshold is set and a PUAS count in excess of the threshold is measured a FAIL result is displayed.

The PUAS threshold is unaffected by the Path Allocation.

M.2100, M.2110, M.2120 Analysis (Option 003 only)

Previously ITU-T G.821 was the only international recommendation available to measure the quality of a communications link. ITU-T G.821 was originally an out-of-service measurement and analysis for commissioning a link and troubleshooting during severe disruption. The commissioning test was a one-month out-of-service test based on errored and severely errored seconds. A one-month test with the subsequent loss of revenue is clearly unacceptable.

Due to demand ITU-T G.821 also evolved into proprietary methods for in-service testing based on FAS and code errors. Demand for high quality leased lines meant an in-service performance standard, closer to real conditions and allowing comparisons between providers, was required.

The ITU-T M.2100 series was specifically defined to provide a clear indication of link quality, for service providers using long term performance analysis. “Bringing into Service” and “repair criteria” analysis were also included.

M.2100 analysis is based on frame errors and provides Error Seconds (anomaly), Severely Errored Seconds (defect) and Unavailability results for receive and transmit directions. Transmit results are only available for 2 Mb/s signals with CRC framing. Out-of-service testing is only available for the receive direction. M.2110 is an out-of-service measurement for “bringing into service” testing of paths. A 15 minute BER test is performed and if this is error free, a 24 hour M.2110 test is performed. If the 24 hour M.2110 test displays PASS (S1 limit not reached) the path can be returned to service. If FAIL is displayed (S2 limit reached or exceeded) the 15 minute BER test should be repeated, If ? (UNCERTAIN) is displayed (result between the S1 and S2 limits) run the 7 day BIS test.

The PASS, FAIL and UNCERTAIN parameters are determined by the S1 and S2 limits which are user selectable.

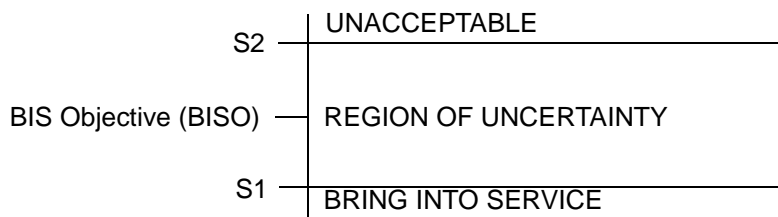

Making Measurements

Measuring Error Analysis

M.2110 BIS (Bring Into Service)

Provides a 15 minute, 2 hour, 24 hour and 7 day PASS, FAIL, ? indication for BIS testing as described in M.2110. The ES and SES results are compared to the S1 and S2 thresholds and indicate PASS, FAIL or ? (uncertain). If the result is “uncertain”, the procedures laid down in M.2110 should be followed.

The S1 and S2 thresholds can be set in two different ways:

- 1 USER - S1 and S2 values are input by the user.
- 2 PATH ALLOCATION - HP ProBER 2 calculates the S1 and S2 values from the user-entered Path Allocation value according to tables and procedures in M.2100.

M.2120 Circuit Maintenance

Provides a threshold report when any of the relevant thresholds are exceeded within a 15 minute (TR1 ES and SES) or 24 hour period (TR2 ES and SES).

The TR1 and TR2 thresholds can be set in two different ways:

- 1 USER - TR1 ES and SES, and TR2 ES and SES values are input by the user.
- 2 PATH ALLOCATION - HP ProBER 2 calculates the TR1 and TR2 values from user-entered Path Allocation and Maintenance Factor values according to M.2120.

HOW TO:

- 1 Set up the transmit and receive interfaces. See “Setting Transmit and Receive Interfaces” on page 4-3.
- 2 Choose the Test Timing required (see “Setting Test Timing” on page 6-2) and start the test by pressing **START/STOP**.
- 3 Choose **MENU**, **Results**, **▼**, **Analysis**, **▶**, then **G.821**, **G.826**, **M.2100**, **M.2110**, or **M.2120** to obtain the Analysis Results menu, as shown.

Menu		Results		
Type:	Analysis		G.821	Bit
	Count	Ratio	Annex D	
ES	0	0.00000	0.00000	
EFS	0	0.00000		
SES	0	0.00000		
DM	0	0.00000		
UAS	0	0.00000		
Result	Pass			
Code Err Secs	0			
Path Allocation	100.000%		00:00:00:00	
? Select the analysis type to be displayed. M2120 available only with 2Mb/s Rx pattern set to LIVE				
<div style="display: flex; justify-content: space-around;"> G.821 G.826 M.2100 M.2110 </div>				

Making Measurements

Measuring Error Analysis

NOTE

M.2100 analysis is an in-service measurement and therefore is only available when the test pattern is set to live.

- 4 Choose G.821 (Bit, FAS, CRC or E-Bit), G.826 (in-service or out-of-service), M.2100, M.2110 or M.2120 analysis results for viewing, as appropriate.

NOTE

Once a test has been run, you can switch between the various analysis types to view the results without losing data.

Making Measurements

Performing a Trouble Scan

Performing a Trouble Scan

Description:

Problems in the network at all levels of the hierarchy can be detected by the occurrence of errors and alarms.

When performing a Trouble Scan all possible error sources and alarms are scanned simultaneously.

Any error count which is other than zero is displayed.

Up to four non-zero error counts are displayed in priority order:

- CRC
- E BIT
- CODE
- FAS
- BIT
- Jitter Hits (Option 001 only)

If any alarms are active an Alarm Seconds count is displayed.

HOW TO:

- 1 Set up the receive interface and if necessary the transmit interface. See “Setting Transmit and Receive Interfaces” on page 4-3.
- 2 Choose the Test Timing required (see “Setting Test Timing” on page 6-2) and start the test by pressing **START/STOP**.
- 3 Choose **MENU**, **Results**, **▼**, **Trouble Scan** to obtain the Trouble Scan display, as shown.

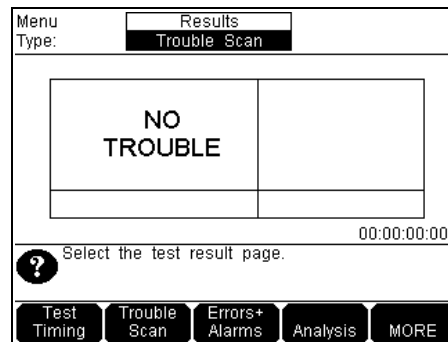

Making Measurements

Measuring Round Trip Delay

Measuring Round Trip Delay

Description:

The time taken for voice or data traffic to pass through the network is very important as excessive delay adds distortion. Speech is particularly affected by delays longer than 150 ms.

Round Trip Delay is a measurement of the total delay on the 'go' and 'return' legs of a duplex path and is typically in the order of milliseconds.

HP ProBER 2 measures the time taken for a test pattern to be transmitted over the 'go' and 'return' legs of a duplex network path.

A test pattern is transmitted in an $n \times 64$ kb/s path (or 2 Mb/s unframed path) and a timer is set running. A loopback is manually applied to the network equipment to return the test signal.

The received pattern stops the timer and the round trip delay is calculated.

NOTE

1. Round trip delay is only possible at 2 Mb/s Line Rate.
 2. Any error measurement must be stopped before the delay measurement can be made.
 3. The delay measurement must be terminated before an error measurement can be started.
-

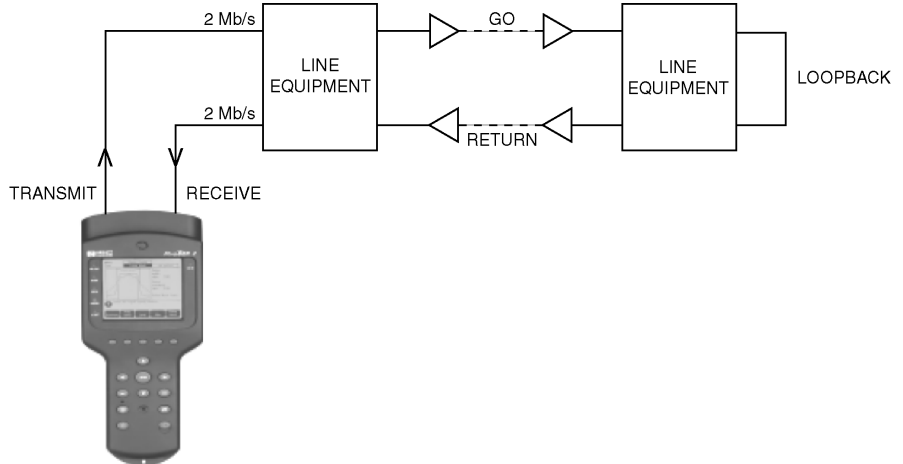

Making Measurements

Measuring Round Trip Delay

HOW TO:

- 1 If an error measurement is running, press **START/STOP** to terminate the measurement.
- 2 Set up the transmit and receive interfaces. See “Setting Transmit and Receive Interfaces” on page 4-3.
- 3 Connect a loopback to the network equipment.
- 4 Choose **MENU**, **Results**, **▼**, **MORE**, **Delay** to view the delay results, as shown.

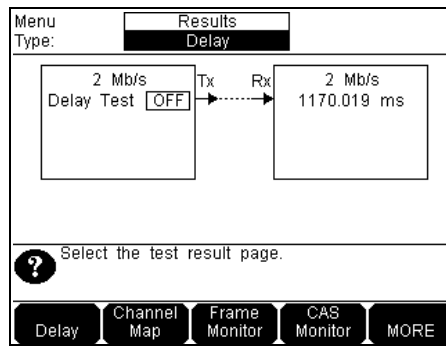

- 5 Choose **Delay Test ON** to start the measurement.
The delay measurement range is up to 2 seconds with a resolution of 1 ms.

Making Measurements

Measuring Frequency and Frequency Offset

Measuring Frequency and Frequency Offset

Description: HP ProBER 2 measures the frequency of a received 2 Mb/s signal relative to the internal reference clock.

The frequency offset is also measured within the limits specified in ITU-T G.703 < ± 50 ppm. For more information on frequency offset, see “Adding Frequency Offset” on page 5-3.

NOTE

Frequency measurement is not available when a Line Rate of 64 kb/s is chosen.

HOW TO:

- 1 Set up the receive interface. See “Setting Transmit and Receive Interfaces” on page 4-3.
- 2 Choose **MENU**, **Signal Quality**, **▼** **Frequency** to obtain the Frequency display, as shown.

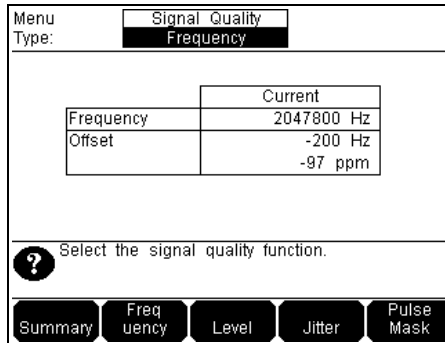

The screenshot shows the 'Signal Quality' menu with 'Frequency' selected. It displays a table with the following data:

	Current
Frequency	2047800 Hz
Offset	-200 Hz
	-97 ppm

Below the table, there is a question mark icon and the text 'Select the signal quality function.' At the bottom, there are five buttons: 'Summary', 'Frequency', 'Level', 'Jitter', and 'Pulse Mask'.

Making Measurements

Making Pulse Mask Measurements (Option 001 only)

Making Pulse Mask Measurements (Option 001 only)

Description:

The received pulse is superimposed on the ITU-T G.703 mask and a comparison is made. A **Pulse Mask**: Pass or Fail result is displayed.

The comparison can be made on positive or negative pulses. Alternatively, the Pulse Mask can be turned off and no comparison made.

Pulse width ratio and pulse amplitude ratio results are also displayed. The ratios are calculated from positive with respect to negative.

NOTE

1. Pulse Mask measurement is only possible when Option 001, Advanced Signal Quality Measurements, is fitted.
2. Pulse Mask measurement is not available when a Line Rate of 64 kb/s is chosen.
3. Results in the Signal Quality Summary are separate from those recorded in the Pulse Mask measurement.

HOW TO:

1. Set up the receive interface. See “Setting Transmit and Receive Interfaces” on page 4-3.
2. Choose **MENU**, **Signal Quality**, **▼**, **Pulse Mask** to obtain the Pulse Mask display, as shown below, and then press **START/STOP** to start the pulse capture.
The status message “*Pulse capture in progress*” indicates that the measurement has started.
3. When the pulse is displayed, enable or disable the ITU-T G.703 Mask and choose the captured pulse polarity.

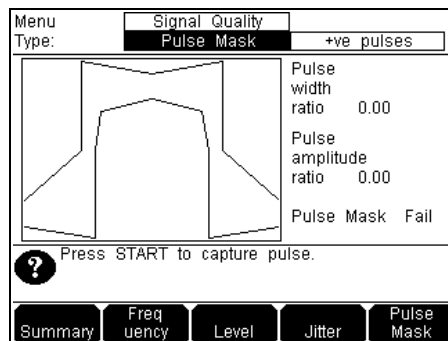

Making Measurements

Measuring Signal Level (Option 001 only)

Measuring Signal Level (Option 001 only)

NOTE

1. Signal Level measurement is only possible when Option 001, Advanced Signal Quality Measurements, is fitted.
2. Signal Level measurement is not available when Jitter or the Co-directional interface is chosen.
3. Low level signals can be measured by selecting Monitor modes on the **TX/RX Setup** display.

HOW TO:

- 1 Set up the receive interface. See “Setting Transmit and Receive Interfaces” on page 4-3.
- 2 Choose **MENU**, **Signal Quality**, **▼**, **Level** to obtain the Level Results, as shown.

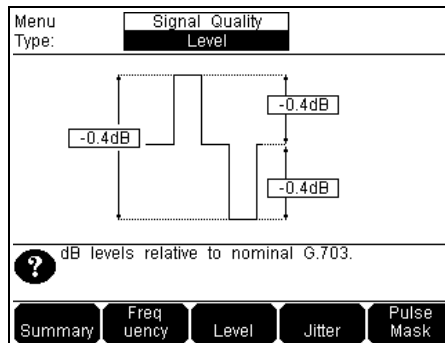

Making Measurements

Measuring Jitter

Measuring Jitter

Description:

Simultaneous Jitter and Error measurements are made when jitter option 001 is fitted to HP ProBER 2 and the jitter measurement is enabled. Jitter measurements are to ITU-T standard O.172.

Jitter Amplitude and Jitter Hits results are provided:

- **Amplitude** - Peak to Peak, Positive Peak, Negative Peak
- **Hits** - Hit count, Hit seconds, Hit free seconds

A selection of jitter filters is provided to allow received jitter to be compared with the maximum input tolerance of the ITU-T G.823 and G.783 masks:

- HP1 - 20 Hz high pass
- HP2 - 18 kHz high pass
- LP - 100 kHz low pass

Filters **OFF** allows jitter measurement in the range 2 Hz to greater than 100 kHz on the 1.6 UI range.

The 16 UI range is particularly useful in identifying jitter originating from pointer movements.

NOTE

1. Jitter measurement is only possible when Option 001, Advanced Signal Quality Measurements, is fitted.
2. Jitter measurement is not available when a Line Rate of 64 kb/s is chosen.
3. When Jitter measurement is enabled the Line Level, Pulse Mask and Error Add features are not available.

HOW TO:

- 1 Set up the receive interface and transmit interface if necessary. See “Setting Transmit and Receive Interfaces” on page 4-3.
- 2 Choose **[MENU]**, **Signal Quality**, **▼**, **Jitter** to configure the jitter receiver and view the jitter results.
- 3 Enable the jitter measurement by choosing **ON**.
- 4 Choose the jitter measurement range required from the menu (1.6 UI or 16 UI).

Making Measurements

Measuring Jitter

- 5 Move the cursor to **Hit Threshold** and using **Edit**, **◀**, **▶**, **▼**, **▲** choose the hit threshold value.
Press **ENTER** to action your edits. Press **Cancel** to escape.
- 6 Choose the jitter measurement filter required from the menu.
- 7 Choose the Test Timing required (see “Setting Test Timing” on page 6-2) and start the test by pressing **START/STOP**.
- 8 Any of the other results can be viewed without affecting the measurement.

Menu	Signal Quality			
Type:	Jitter(0.172)	On		
Range:	1.6UI	Hit Threshold: 1.00 UI		
Filter:	Off			
	Total	Current		
Peak-Peak	0.000 UI	0.000 UI		
+ve Peak	0.000 UI	0.000 UI		
-ve Peak	0.000 UI	0.000 UI		
Hit Count	0	0		
Hit Secs	0	-		
Hit Free Secs	0	-		
	00:00:00:00			
	Select the Jitter Filter.			
Off	LP	HP1	HP2	MORE

Making Measurements

Measuring a VF Tone (Using Channel Map)

Measuring a VF Tone (Using Channel Map)

HP ProBER 2 measures the frequency and level of a voice frequency tone in a selected timeslot.

The measured VF tone frequency and level is available on the **Results Channel Map** display.

Channel Map allows you to scan all the received timeslots. Any timeslot which has activity is highlighted (indicated by black shading).

The display softkeys can be used to jump between “active” timeslots.

The loudspeaker volume can be adjusted to give an audible indication of timeslot activity.

The frequency and level of the tone, in the chosen timeslot, are displayed.

NOTE

1. When generating a VF tone, the frequency and level of the received VF tone also appear on the **Test Setup VF Tone** display. For more information, see “Generating a VF Tone” on page 5-7
2. VF Tone measurement is not available when error measurements are running or a Line Rate of 64 kb/s is chosen.





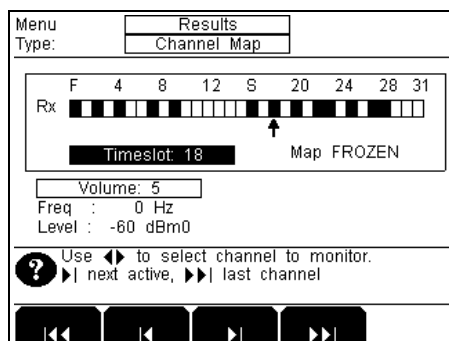



HOW TO:

- 1 Set up the receive interface and if necessary the transmit interface. See “Setting Transmit and Receive Interfaces” on page 4-3.
- 2 Choose **MENU**, **Results**, **▼**, **MORE**, **Channel Map** to obtain the Channel Map display. Note that this display is not available when an unframed frame structure is chosen on the Tx/Rx setup.



Making Measurements

Measuring a VF Tone (Using Channel Map)

- 3 Move the cursor to **Timeslot** and choose the timeslot to monitor.
 and  move the pointer to first/last timeslot.  and  move the pointer from the “active” timeslot to next/previous “active” timeslot.  and  move the pointer to the adjacent timeslot.
The level and frequency of the tone is displayed at the bottom of the display.
- 4 If required adjust the loudspeaker volume level using  and .

Making Measurements

Monitoring Signaling Bits

Monitoring Signaling Bits

Description:

For information, see “Setting Signaling Bits” on page 5-4.

HOW TO:

- 1 Choose **MENU**, **Results**, **▼**, **MORE**, **MORE**, **CAS Monitor** to obtain the CAS Monitor display, as shown.

Menu		Results							
Type:		CAS Monitor							
TS	ABCD	TS	ABCD	TS	ABCD	TS	ABCD	TS	ABCD
1	0001	9	1001	17	1111	25	0111		
2	0010	10	1010	18	1110	26	0110		
3	0011	11	1011	19	1101	27	0101		
4	0100	12	1100	20	1100	28	0100		
5	0101	13	1101	21	1011	29	0011		
6	0110	14	1110	22	1010	30	0010		
7	0111	15	1111	23	1001	31	0001		
8	1000			24	1000				

? Select the test result page.

Delay	Channel Map	Frame Monitor	CAS Monitor	MORE
-------	-------------	---------------	-------------	------

NOTE

This display is available only when a PCM30 or PCM30CRC frame structure is chosen on the Tx/Rx setup.

Making Measurements

Monitoring Spare Bits

Monitoring Spare Bits

Description:

HP ProBER 2 displays the Synchronization Status Message in the chosen Sa Bit and the value of all the Sa Bits. For more information, see “Setting Spare Bits” on page 5-5.

HOW TO:

- 1 Choose **MENU**, **Results**, **▼**, **MORE**, **Sa Bit Monitor** to obtain the Spare Bits Monitor display.
- 2 Choose the Sa Bit to be monitored for Synchronization Status Messages. Each Sa Bit can be chosen in turn without affecting the measurement.

Menu	Results			
Type:	Sa Bit Monitor			
Sync. Message <input type="text" value="Sa4"/> Quality Unknown				
	SMF1	SMF2		
Sa4	0000	0000		
Sa5	0000	0000		
Sa6	0000	0000		
Sa7	0000	0000		
Sa8	0000	0000		
? Select the test result page.				
Delay	Channel Map	Frame Monitor	Sa Bit Monitor	MORE

NOTE

The Spare Bits Monitor display is available only when a PCM30CRC or PCM31CRC frame structure is chosen on the Tx/Rx setup.

Making Measurements

Monitoring Framing Bits

Monitoring Framing Bits

Description:

For more information, see “Setting Framing Bits” on page 5-6.

HOW TO:

- 1 Choose **MENU**, **Results**, **▼**, **MORE**, **Frame Monitor** to obtain the Frame Monitor display.

Menu	Results	
Type:	Frame Monitor	
	SI	FAS
Timeslot-0 (FAS)	01	0110111
	SI	A Sa4-Sa8
Timeslot-0 (NFAS)	0111	00101
	MFAS	xxxx
Timeslot-16 (Frame-0)	0000	0011
Select the test result page.		
Delay	Channel Map	Frame Monitor
	CAS Monitor	MORE

NOTE

This display is not available when an unframed frame structure is chosen on the Tx/Rx setup.

Results

Once you've made your measurement, you'll want to view the results or save them for future reference. This chapter gives you the information on how to do this.

Results

Saving Graphs Results

Saving Graphs Results

Description:

HP ProBER 2 can graphically present the following results:

- Correlation of error, jitter and alarm results
- Display of error, jitter and alarm results versus time
- Overview of the results which can be stored in the instrument for record keeping.

Up to 10 sets of measurement results can be stored in HP ProBER 2.

HOW TO:

- 1 Choose **MENU** , **More** , **Graphs** to obtain the graphs results display. Note, you can access this display before, during or after performing a measurement.
- 2 When the measurement is complete, move the cursor to **Store** and choose **Select Store**. Note that when the measurement is in progress, the **Store** field shows **CURRENT** and changes to **EMPTY** when the measurement is complete, as shown.

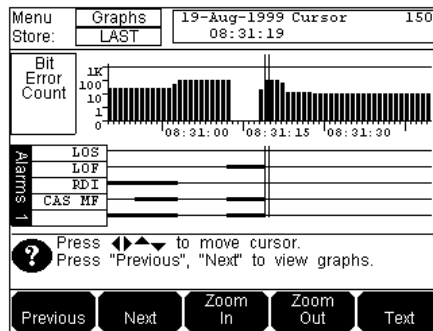

- 3 Use **▼** and **▲** to access the instrument store in which you wish to store the graph results. Stores 1 to 9 are available.
- 4 Choose **Save** to confirm the saving of the graph results obtained from the “last” measurement.
Choose **Cancel** to exit without saving the graph results.
Choose **ENTER** to view the graph results from the selected store.
Choose **Delete** to clear the contents of the selected store.

Results

Recalling Graphs Results

Recalling Graphs Results

Description: Results stored from a previous measurement can be recalled to the graphs display for viewing.

HOW TO:

- 1 Choose **MENU**, **More**, **Graphs** to obtain the graphs display.
- 2 Move the cursor to **Store** and choose **Select Store**.
- 3 Use **▼** and **▲** to access the instrument store which contains the graphs results you wish to recall.
- 4 Choose **ENTER** to recall the graphs results from the selected store to the display.
Choose **Cancel** to exit without recalling the graphs results.
Choose **Delete** to clear the contents of the selected store.

Menu	Graphs		
Store:	2		
#	Start	Duration	Events
9			
8			
7			
6			
5			
4			
3	03/08/1999 10:19	00:00:00:10	0
2	03/08/1999 10:17	00:00:01:00	0
1	03/08/1999 10:16	00:00:00:10	0
LAST	03/08/1999 10:19	00:00:00:10	0

? ▲▼ : select store. "Enter": view store.
"Save": store LAST, "Delete": clear store.

LAST	Save	Delete	Cancel
------	------	--------	--------

Results

Viewing Graphs Results

Viewing Graphs Results

Description:

All the graphs results obtained during the measurement are available for viewing.

Although results are recorded with a resolution of 1 second, **Zoom In** and **Zoom Out** allow you to dynamically change the resolution used to display the graphs results. Resolutions of 1 second, 1 minute, 15 minutes and 1 hour are available.

You can move the cursor to a particular area of interest using ◀ and ▶. The cursor position is displayed at the top right of the display as a time and date.

The graphs results can also be viewed in text format as cumulative results. The Error Count graphs give text results of Error Count, Error Ratio and Error Seconds. The Alarm graphs give text results of Alarm Seconds.

HOW TO:

- 1 Choose **MENU**, **More**, **Graphs**, ▼, **Select Store**, ▼, ▲ and then press **ENTER** to obtain a graph display of your choice.
- 2 Use ▼ and ▲ to move between the upper and lower graphs.
- 3 Use **Next** and **Previous** to scroll through the graph results.
- 4 Use ◀ and ▶ to move the graph cursor to the area of interest.
- 5 Use **Zoom In** and **Zoom Out** to allow more detailed inspection of the graph results by reducing/increasing the time axis.
- 6 Press **Text** to view text results. Press **Graph** to return to graph results.

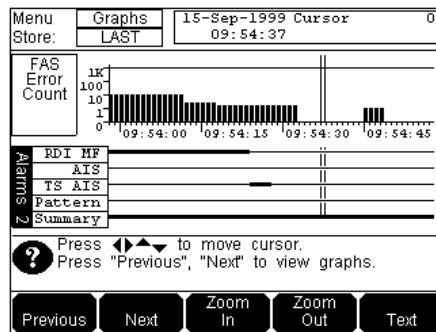

Results

Logging Results to a Printer

Logging Results to a Printer

Description:

There are two ways of logging results to a printer: test period logging in which selected results are logged at the end of the test period, and error event logging in which results are logged at each occurrence of the selected error event.

Test Period Logging

If degradations in system performance can be observed at an early stage, then the appropriate remedial action can be taken to maximize circuit availability and avoid system crashes. Test period logging allows you to monitor the error performance of your circuit. At the end of the test period the selected results are logged.

Results can also be logged at regular intervals during the test period by selecting a **Logging Interval** of shorter duration than the test period.

Error Event Logging

Manual tracing of intermittent faults is time consuming. Error event logging allows you to carry out unattended long-term monitoring of the circuit. Each occurrence of the selected error event is logged.

Any occurrence of an alarm results in a timed and dated message being logged.

HOW TO:

- 1 Choose **MENU**, **More**, **Log/Print** to obtain the Logging display.
- 2 Select **Filters**, as shown, and choose the result(s) to be logged.

The screenshot shows a menu titled "Log/Print" with a sub-option "Filters" selected. The menu lists several logging options, each with a corresponding "Off" button to its right. At the bottom, there is a question mark icon and the text "Select the logging sub page." with two buttons: "Setup" and "Filters".

Menu	Log/Print
Select:	Filters
Interval Results:	Off
Total Results:	Off
Error Counts:	Off
Alarm Seconds:	Off
G.821:	Off
G.826:	Off
M.2100:	Off
Frequency:	Off
Signal Level:	Off

? Select the logging sub page.

Setup Filters

Interval Results - Log results obtained during the Logging Interval.

Total Results - Log cumulative results obtained since the start of the measurement.

Results

Logging Results to a Printer

Error Counts - Log all valid error counts (Bit, Code, FAS, CRC, E-bit).

Alarm Seconds - Log Alarm Seconds.

G.821 - Log chosen G.821 results (All, Bit, FAS, CRC or E-Bit).

G.826 - Log chosen G.826 results (All, In-Service or Out of Service).

M.2100 - Log chosen M.2100 results (All, M.2100, M.2110, M.2120).

Frequency - Log the received frequency.

Signal Level - Log the received signal level.

Each or all of these Filters can be switched **OFF**.

- 3 Select **Setup**, as shown, and choose the logging Setup.

Menu	Log/Print
Select:	Setup
Logging Mode:	Off
Log Errored Secs:	Off
Logging Interval:	Meas. Period
Log When:	Always
Printer Type:	HP
Printer Baud Rate:	9600 baud
? Select the logging sub page.	
Setup	Filters

Logging Mode - Enables logging.

Log Errored Secs - Provides a timed and dated message each time an error or alarm occurs.

Logging Interval - Choose the interval for logging results to the printer. If **User** is chosen use **◀**, **▶**, **▼** and **▲** to choose the logging interval.

Log When - Log always or only when error count is greater than zero.

Printer Type - Choose HP or alternative supplier's printer according to type of printer connected.

Printer Baud Rate - Choose rate at which logging is transferred to the chosen printer.

Results

Connecting an HP 15730A/B Printer

Connecting an HP 15730A/B Printer

Description:

An HP 15730A RS-232-C printer can be connected to the PRINTER port of HP ProBER 2 for result logging.

HOW TO:

- 1 Connect the HP 15730A/B printer to HP ProBER 2's PRINTER port using the appropriate cable.
If the printer has a 25-pin connector, use HP 24542M.
If the printer has a 9-pin connector, use HP 15736A.
- 2 Choose the printer Baud Rate to match the Baud Rate chosen on the **MENU** , **More** , **Log/Print** , **Setup** display. See "Logging Results to a Printer" on page 7-5.
- 3 Choose **Printer Type HP** on the **MENU** , **Log/Print** , **Setup** display. See "Logging Results to a Printer" on page 7-5.

Results

Printing a Display

Printing a Display

Description:

You can output any of the HP ProBER 2 displays to a printer for record keeping or as an illustration of test procedures.

HOW TO:

- 1 Obtain the display required and press **PRINT**.

Results

Logging Results to a PC

Logging Results to a PC

Description:

Instead of logging results to a printer, you can log them to a PC for future processing. The output from HP ProBER 2 is taken from the PRINTER port.

HOW TO:

- 1 Choose **MENU**, **More**, **Log/Print** to obtain the Logging display.
- 2 Select **Setup** and set the logging Setup to that shown below.

Menu	Log/Print
Select:	Setup
Logging Mode:	On
Log Errored Secs:	On
Logging Interval:	Meas. Period
Log When:	Always
Printer Type:	Alt
Printer Baud Rate:	9600 baud
? Select the logging sub page.	
Setup	Filters

- 3 Select **Filters** and set the results to be logged, as shown below.

Menu	Log/Print
Select:	Filters
Interval Results:	Off
Total Results:	On
Error Counts:	On
Alarm Seconds:	On
G.821:	All
G.826:	All
Frequency:	On
Signal Level:	On
? Select the logging sub page.	
Setup	Filters

Results

Logging Results to a PC

- Using an RS-232-C (male-to-female) crossover cable, connect the PRINTER port of HP ProBER 2 to the COM X port of your PC. Here are the pin connections:

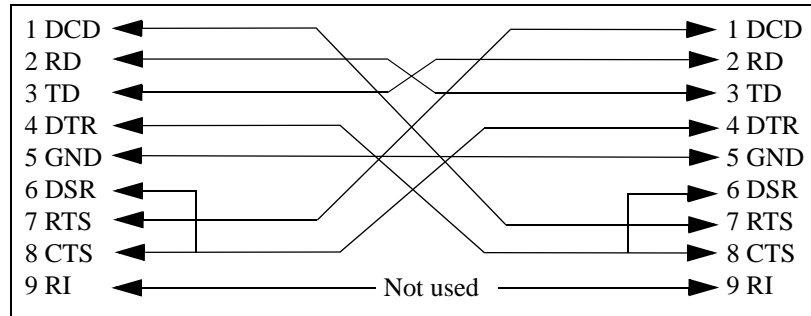

HP 24542U is a suitable cable.

- On your PC, get your Hyperterminal (it may be installed as part of your Accessories), or alternative, and set up as follows:
Setup: COMX (e.g. COM1, as appropriate for your PC)
Bits Per Second: 9600
Data Bits 8
Parity: None
Stop Bits: 1
Flow Control: Xon/Xoff
- To capture text to a file, select Transfer from the main menu, then Capture Text . . . Enter a name for the capture file and then press Start.
- On HP ProBER 2, press **START/STOP** to start a measurement. HP ProBER 2 will provide setup information to the file.
- Press **START/STOP** to stop the measurement. HP ProBER 2 will provide all the results you selected in the Filters Setup in step 3, above.
- To stop the data transfer, on the PC select Transfer from the main menu, then Capture Text . . ., then Stop.
- The file may be viewed using any text editor, e.g. NotePad.

NOTE

The **PRINT** key on HP ProBER 2 does not work in this procedure.

Using “Other” Features

This chapter gives full details on all the features that are accessed from the **Other** softkey, such as setting the time, choosing the local language help messages and setting the display contrast level.

Using "Other" Features

Setting Time and Date

Setting Time and Date

Description:

When recording results, it is useful to have certain events time-stamped, for example, Alarms, Error Seconds.

HOW TO:

- 1 Choose **MENU**, **MORE**, **Other**, **▼**, **MORE**, **Time/Date** to obtain the Time and Date display, as shown.

Menu: Other
Type: Time/Date

Date: 6 Aug 1999
Time: 7:11:48

? Select the desired function.

Time/Date Inst. Config Calibration Options MORE

- 2 Move the cursor to **Date** and enter the correct date using **Edit**, **◀**, **▶**, **▼** and **▲**.
Press **ENTER** to action your edits or press **Cancel** to escape.
- 3 Move the cursor to **Time** and enter the correct time using **Edit**, **◀**, **▶**, **▼** and **▲**.
Press **ENTER** to action your edits or press **Cancel** to escape.

Using "Other" Features

Storing and Titling Instrument Settings

Storing and Titling Instrument Settings

Description:

Up to 4 sets of user defined instrument settings can be stored in HP ProBER 2 and each set can be given a title for ease of identification.

One preset store is provided which cannot be overwritten, **STORE 0**. This store is used to set the instrument to a known state, the **FACTORY DEFAULT SETTINGS**.

HOW TO:

- 1 Choose **MENU**, **MORE**, **Other**, **▼**, **Inst Settings** to obtain the stored settings display, as shown.

The screenshot shows a menu interface with the following elements:

- Menu: Other
- Type: Inst. Settings
- Overwrite Protection: On
- A list of memory locations:
 - 0 :Factory Default Settings
 - 1 :.....
 - 2 :.....
 - 3 :.....
 - 4 :.....
- A question mark icon and the text "Select the desired function."
- A row of five buttons: Self Test, Talk/ Listen, Inst. Settings, Battery Life, and MORE.

- 2 Choose **Overwrite Protection OFF**.
- 3 Choose the memory location in which you wish to store your instrument settings using **▼** and **▲**.
- 4 Choose **Save** to store your instrument settings in the chosen memory location. Use **Edit**, **INS**, **DEL**, **◀**, **▶**, **▼** and **▲** to enter the title. A full range of alphanumeric characters is available for your title. Press **ENTER** to action your edits or press **Cancel** to escape.
- 5 Choose **Overwrite Protection ON**.

Using "Other" Features

Recalling Instrument Settings

Recalling Instrument Settings

Description:

Having stored a complete set of measurement settings, you must be able to Recall those settings for use at a later date.

HOW TO:



- 1 Choose **MENU**, **MORE**, **Other**, **▼**, **Inst Settings** to obtain the stored settings display.
- 2 **Overwrite Protection** **OFF** or **ON** may be chosen.
- 3 Choose the memory location (0 to 4) from which you wish to recall the instrument settings.
Press **Recall** to recall your instrument settings, as shown.

The screenshot shows a menu interface with the following elements:

- Menu: Other
- Type: Inst. Settings
- Overwrite Protection: On
- A list of memory locations: 0: Factory Default Settings, 1: Test_Procedure_A (highlighted), 2:, 3:, 4:
- A question mark icon and the text: "Select the required action on the selected store".
- A "Recall" button.

Instrument Reset (Cold Start)

If you cannot control HP ProBER 2 using the front panel keys, in other words the software has “hung”, perform an Instrument Reset (Cold Start).

- 1 Press and hold down the On/Off key  for at least 7 seconds.
- 2 To restore power, press  again. HP ProBER 2 will return to the Default settings but any data previously stored in memory will be lost.

NOTE

This procedure applies only when the software has “hung”. Holding  down for at least 7 seconds will switch HP ProBER 2 back on again when the software is operating normally.

Using "Other" Features

Setting Beep on Error/Alarm

Setting Beep on Error/Alarm

Description:

When the test set display is not directly in your view it is particularly useful to have an audible indication of Errors and Alarms.

You can set HP ProBER 2 to beep on errors of a particular type or beep on all error types.

Similarly you can set HP ProBER 2 to beep on a particular alarm or beep on any alarm.

HOW TO:

- 1 Choose **MENU**, **MORE**, **Other**, **▼**, **MORE**, **Inst Config** to obtain the Beep on Error and Beep on Alarm display.
- 2 Choose the type of error under **Beep On Error**.
- 3 Choose the type of alarm under **Beep On Alarm**.

Menu	Other			
Type:	Inst. Config			
Beep On Error:	Off			
Beep On Alarm:	All			
Backlight:	Timed	10 Minutes		
Display Contrast:	14			
Language:	English			
? Select the type of alarm for beep.				
Off	All	LOS	LOF	MORE

Using "Other" Features Setting Backlight Mode

Setting Backlight Mode

Description:



Under certain lighting conditions it may be difficult to read the display. The Backlight capability improves the clarity of the display under those conditions.

You can choose to have the Backlight:

- Switched off.
- Switch off 10 minutes after the last key press, saving battery power.
or
- Switched on continuously.

The Backlight is switched ON and OFF using . This key has dual functionality. A quick press operates the backlight switch. A sustained press causes the display contrast to cycle through its adjustment range.

HOW TO:

- 1 Choose **MENU**, **MORE**, **Other**, , **MORE**, **Inst Config** to obtain the Backlight display.
- 2 Move the cursor to the **Backlight** field.
If **Timed** is chosen the backlight will switch off 10 minutes after the last key press.
If **Continuous** is chosen, the backlight will remain on until it is switched off by pressing the  key.



Menu	Other	
Type:	Inst. Config	
Beep On Error:	Off	
Beep On Alarm:	Off	
Backlight:	Timed	10 Minutes
Display Contrast:	14	
Language:	English	
	Select backlight operation. 'Timed' will switch off the backlight after set time.	
Cont - inuous	Timed	

Using "Other" Features Setting Display Contrast



Setting Display Contrast



Description: The readability of the HP ProBER 2 display can be adjusted using the display contrast control.

NOTE

If the display is difficult to read, press and hold down the Backlight key . This will cause the contrast to cycle through its range. Simply release the  key when the desired contrast is reached.

HOW TO:

- 1 Choose **MENU**, **MORE**, **Other**, , **MORE**, **Inst Config** to obtain the Contrast display.
- 2 Use the  and  softkeys to set the optimum contrast level while viewing the display.

Menu	Other	
Type:	Inst. Config	
Beep On Error:	Off	
Beep On Alarm:	Off	
Backlight:	Timed	10 Minutes
Display Contrast:	14	
Language:	English	
	Set the display contrast.	
 		

Using "Other" Features

Choosing Local Language Help Messages

Choosing Local Language Help Messages

Description:

The HELP messages displayed on the screen can be provided in English and one other language. The other language depends on which HP ProBER 2 option you have ordered.

HOW TO:

- 1 Choose **MENU**, **MORE**, **Other**, **▼**, **MORE**, **Inst Config** to obtain the local language display.
- 2 Scroll down to **Language** and choose the language required from the menu.

Menu	Other	
Type:	Inst. Config	
Beep On Error:	Off	
Beep On Alarm:	Off	
Backlight:	Timed	10 Minutes
Display Contrast:	14	
Language:	English	
? Select the language.		
English Chinese		

Using "Other" Features

Charging the Battery

Charging the Battery

Description:

HP ProBER 2 contains high-capacity Nickel Metal Hydride (NMH) rechargeable batteries.

HP ProBER 2 is supplied with a 15 V dc charger unit which requires an ac power supply between 100 and 240 V, at frequencies between 47 and 63 Hz.

CAUTION

Always use the dc charger unit supplied with HP ProBER 2 for the shortest charge times and best capacity. Performance limitations and damage may occur if other dc charger units are used.

Before use

Before using HP ProBER 2 for the first time, it is recommended that you:

- Power up HP ProBER 2 and allow it to discharge completely.
- Charge the batteries until the battery gauge shows full charge. This normally takes about 5 hours but can take longer if HP ProBER 2 has been in storage for a prolonged time and the batteries have discharged well beyond their normal operating range.

When using HP ProBER 2 after its first charge, allow it to fully discharge before next recharging.

NOTE

During the charging cycle some heat may be apparent on the case of HP ProBER 2. This is normal and is due to the fast charge applied to the batteries.

Normal Use

Normally the batteries will be fully charged after 5 hours. It is good practice to allow a 1 hour rest period after charging to allow the battery chemistry to stabilize and obtain the highest battery capacity.

The longest time between charges is obtained in **RX Only** mode with BER measurements running.

The following functions reduce the operating hours:

- Backlight enabled
- **Tx + Rx** operating mode

Using "Other" Features

Charging the Battery

- Jitter measurements (Option 001 only)
- Pulse Mask measurements (Option 001 only)
- 64 kb/s operation (Option 002 only)

Battery Gauge Indication

The battery gauge indicator can be accessed on the **MENU**, **MORE**, **Other**, **▼** **Battery Life** display and indicates the remaining battery capacity. Wait for approximately 3 minutes for the display to stabilize. The indicator monitors the amount of charge input to the batteries and output from the batteries. It allows for self discharge when HP ProBER 2 is switched on and takes account of the ambient temperature.

NOTE

The battery gauge learns the actual capacity of the batteries by observing a previous discharge. If the batteries are frequently topped up from a partially charged state, the accuracy of the battery gauge will be reduced until a full charge/discharge cycle is next performed.

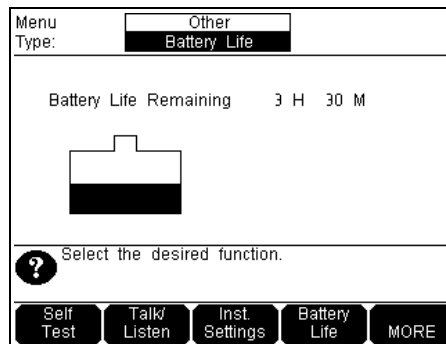

Using "Other" Features Running Self Test

Running Self Test

Description:

Before making measurements, you can run Self Test to ascertain the integrity of HP ProBER 2. There are three different levels of Self Test:

- **Quick Tests** - Requires a 75Ω loopback. Performs a functional test of the processor and BER circuits and completes in less than a minute.
- **Auto Tests** - Requires a 75Ω loopback. Performs a comprehensive set of self tests **All Tests** and takes a few minutes to complete. The tests included in **All Tests** can be run individually and are intended for use by service technicians in a troubleshooting or repair situation.
- **Manual Tests** - Require some level of operator assistance. Select each test in turn and follow the screen instructions. These tests verify the alarm LEDs, display, keypad and co-directional interface, when fitted.

It is recommended that you run the Quick Test level of self test as a quick confidence test before use.

If necessary you can run Auto Test for more comprehensive testing but this takes a few minutes to complete.

HOW TO:

- 1 Choose **MENU**, **MORE**, **Other**, **▼**, **Selftest**, **▶** to obtain the Self Test display, as shown.

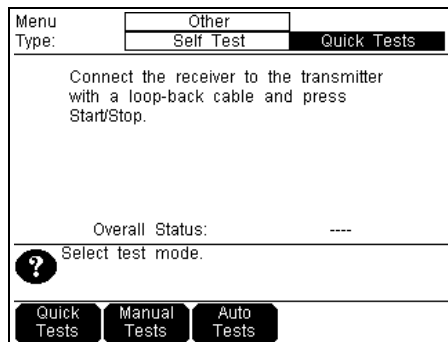

Using "Other" Features

Running Self Test

Run Quick Tests (15 Seconds)

- 1 Choose **Quick Tests**.
- 2 Connect the TRANSMIT 75Ω port to the RECEIVE 75Ω port.
- 3 Press **START/STOP** to run the Self Test.
After a few seconds an **Overall Status** PASS or FAIL message will be displayed.

Run Auto Tests (5 minutes)

- 1 Choose **Auto Tests**, **All Tests**.
- 2 Connect the TRANSMIT 75Ω port to the RECEIVE 75Ω port.
- 3 Press **START/STOP** to run the Self Test.
While the tests are running the **Test Name**, **Subtest Number** and **Test Status** are updated on the display to show the progress of the test.
If a failure is detected the test will halt and **Overall Status** FAIL will be displayed.
At the completion of the test without failure **Overall Status** PASS will be displayed.

Fail Number	Description	Fail Number	Description
1xxxx	CPU	5xxxx	BER
2xxxx	Real Time Clock	6xxxx	Pulse Mask
3xxxx	Line Level	7xxxx	Jitter
4xxxx	Clock	8xxxx	Delay

Run Manual Tests

- 1 Choose **Manual Tests**, then follow the on-screen instructions for the test chosen.

Index

A

- Accessing displays 3-2
- Add
 - alarms or errors 5-2
 - frequency offset 5-3
- Alarm
 - add 5-2
 - beep on 8-5
 - measurement 6-4
 - results 6-4
 - type 5-2
- Alarm LED 3-5
- Altitude, operating 2-2
- Analysis measurement 6-6
- Autosetup 4-5

B

- Backlight
 - continuous 8-6
 - mode 8-6
 - timed 8-6
- Battery
 - charging 8-9
 - gauge indication 8-10
 - life 8-9
- Battery Power 2-5
- Battery Replacement 2-6
- Beep on error/alarm 8-5

C

- Cabinet Cleaning 2-8
- Channel associated signaling 5-4
- Channel map 6-18
- Charging battery 8-9
- Cleaning cabinet 2-8

Clock

- IN port 4-2
- source 4-4
- Cold start 8-4
- Connecting
 - To the Network 2-7, 4-2
 - To the Power Supply 2-6
- Contrast 8-7, 8-8
- Coupled settings 4-3

D

- Date set 8-2
- dc charger unit 8-9
- dc In LED 3-6
- Delay measurement 6-11
- Dialling 5-9
- Display
 - accessing 3-2
 - contrast 8-7
 - modify data 3-4
 - navigating 3-3
 - print 7-8
 - softkeys 3-2
- DTMF dialling 5-9

E

- Elapsed test time 6-2
- Environment, Operating 2-2
- Error
 - add 5-2
 - analysis measurement 6-6
 - beep on 8-5
 - event logging 7-5
 - measurement 6-4
 - results 6-4
 - sources 6-4
- Error LED 3-6

Index

F

- Frame structure 4-4
- Framing bits
 - set 5-6
- Frequency
 - offset 5-3
 - offset measurement 6-13
- Frequency measurement 6-13
- Front Panel LEDs 3-5

G

- G.821
 - analysis 6-6
 - threshold 6-6
- G.826
 - analysis 6-6
 - threshold 6-6
- Gauge indication battery 8-10
- Generating
 - VF tone 5-7
- Graph
 - cursor 7-4
 - display 3-2
 - resolution 7-4
- Graph results
 - recall 7-3
 - save 7-2
 - text 7-4
 - view 7-4

H

- Handset 5-8
- History LED 3-6
- Humidity, operating 2-3

I

- Initial Inspection 2-2
- Instrument reset 8-4
- Instrument settings
 - recall 8-4
 - store 8-3
 - title 8-3
- Interval results 7-5

J

- Jitter
 - filters 6-16
 - measurement 6-16

L

- Language choice 8-8
- LEDs
 - Alarm 3-5
 - dc In 3-6
 - Error 3-6
 - Front panel 3-5
 - History 3-6
 - Low battery 3-6
 - Signal Loss 3-5
 - Start/Stop 3-6
- Line
 - code 4-4
 - impedance 4-4
 - rate 4-4
- Live word pattern 4-4
- Local language help 8-8
- Log/Print display 3-2

Index

Logging

- alarm seconds 7-6
- cumulative results 7-5
- display 7-8
- error counts 7-6
- error event 7-5
- errored seconds 7-6
- filters 7-5
- frequency measurement 7-6
- G.821 results 7-6
- G.826 results 7-6
- interval 7-6
- interval results 7-5
- M.2100 results 7-6
- mode 7-6
- results to a PC 7-9
- results to a printer 7-5
- signal level 7-6
- test period 7-5

Low Battery LED 3-6

M

M.2100, M.2110, M.2120

- analysis 6-7

Manual test timing 6-2

Measuring

- delay 6-11
- error analysis 6-6
- errors and alarms 6-4
- frequency 6-13
- frequency offset 6-13
- jitter 6-16
- pulse mask 6-14
- signal level 6-15
- VF tone 6-18

Modifying display data 3-4

Monitor

- framing bits 6-22
- termination 4-2
- timeslots 6-19

More softkey 3-3

N

Navigating displays 3-3

O

Other display 3-2

Overwrite thru mode 4-3

P

Path allocation 6-6

Power Cord 2-6

Power Requirements 2-5

Power Supply Connection 2-6

Preparation for Use 2-5

Print

- alarm seconds 7-6
- cumulative results 7-5
- display 7-8
- error counts 7-6
- error event 7-5
- errored seconds 7-6
- frequency 7-6
- G.821 results 7-6
- G.826 results 7-6
- interval results 7-5
- M.2100 results 7-6
- signal level 7-6

Printer

- baud rate 7-7
- connecting 7-7
- HP 15730A/B 7-7

Index

PUAS threshold 6-7
Pulse mask measurement 6-14

R

Recall
 graph results 7-3
 instrument settings 8-4
Receive
 Interface 4-3
 interface termination 4-2
 only 4-3
Reset instrument 8-4
Results
 display 3-2
 graph 7-4
 logging to a PC 7-9
 logging to a printer 7-5

S

Safety Information 2-3
Safety Precautions
 For the Operator 2-3
Safety Symbols 2-4
Save graph results 7-2
Self test 8-11
Set
 backlight 8-6
 display contrast 8-7
 error/alarm beep 8-5
 framing bits 5-6
 signaling bits 5-4
 spare bits 5-5
 time and date 8-2
Settings coupled 4-3
Shipping Container Inspection 2-2
Signal level measurement 6-15
Signal Loss LED 3-5

Signal quality display 3-2
Signaling bits
 set 5-4
Spare bits
 set 5-5
Start/Stop LED 3-6
Store instrument settings 8-3
Symbols, Safety 2-4
Synchronization status message 5-5

T

Telephone handset 5-8
Temperature, operating 2-2
Test period logging 7-5
Test setup display 3-2
Test timing 6-2
Text results 7-4
Threshold
 G.821 6-6
 G.826 6-6
 PUAS 6-7
Thru mode 4-3
Time set 8-2
Timeslots 4-4
Title instrument settings 8-3
Total results 7-5
Transmit
 Interface 4-3
Transparent thru mode 4-3
Trouble scan 6-10
TX/RX setup display 3-2

V

VF tone
 generating 5-7
 measurement 6-18

Index

View

- alarm results 6-4
- channel map 6-18
- delay result 6-11
- error results 6-4
- frequency results 6-13
- G.821 analysis results 6-6
- G.826 analysis results 6-6
- graph results 7-4
- jitter results 6-16
- M.2100 series analysis results 6-7
- pulse mask results 6-14
- signal level result 6-15
- time and date 8-2
- trouble scan 6-10

W

- Word pattern 4-4

